

H507A X4 STAR PRO

《H507A User Manual》

版本号 V2.0

Important safety information

Operation: Be extremely careful and responsible when using the quad. Small electronic components can be damaged due to crashes or exposure to moisture/liquid. To avoid any injuries, do not use the quad with broken or damaged components.

Maintenance: Do not try to open or repair the units by yourself. Please contact Hubsan or Hubsan authorized dealers for service. For more information, please visit the official website at www.hubsan.com.

Battery: Do not disassemble, squeeze, impact, burn, drop or trample the battery. Do not short-circuit or put the battery terminal in contact with metal. Do not expose the battery to temperatures above 60 ° C. Charge the aircraft battery prior to flight. Use a Hubsan dedicated charger for charging. Keep the battery out of the reach of children and away from any kind of moisture.

Flight: Please be mindful of personal safety and the safety of others while flying.

- Do not fly in bad weather conditions.
- Do not attempt to catch the aircraft while it is in flight.
- This product is intended for experienced pilots over the age of 14.
- After every flight, completely disarm the aircraft motors and disconnect the aircraft from power. Then, you may power off the remote control.

Read the Disclaimer and Safety Guidelines first before use.

Symbol explanation:

 Prohibited operation

 Important Notice

 Instruction

 Explanation/reference

Hubsan Safety Advisory Notice for Lithium-Polymer (LiPO) Batteries

LiPo batteries are different from conventional batteries in that their chemical contents are encased in a relatively lightweight foil packaging. This has the advantage of significantly reducing their weight but it does make them more susceptible to damage if roughly or inappropriately handled. As with all batteries, there is a risk of fire or explosion if safety practices are ignored:

- If you do not plan to fly the quad for a long time, store the battery ~50% charged to maintain battery performance and life.
 - Please use Hubsan chargers for battery charging.
 - Discharge the battery at 5C current or below. To avoid discharge related battery damage, do not prolong the discharge time.
 - Do not charge on carpet to avoid fire.
 - Batteries need to be recharged if unused for over 3 months.
- ⊗
1. Do not disassemble or reassemble the battery.
 2. Do not short-circuit the battery.
 3. Do not use or charge near sources of heat.
 4. Do not put the battery in contact with water or any kind of liquid.
 5. Do not charge batteries under sunlight or near fire.
 6. Do not puncture or subject the battery to force of any kind.
 7. Do not throw or manhandle the battery.
 8. Never charge a battery that has been damaged, become deformed or swelled.
 9. Do not solder on or near the battery.
 10. Do not overcharge or over discharge the battery.
 11. Do not reverse charge or reverse the battery polarities.
 12. Do not connect the battery to a car charger/cigarette lighter or any kind of unconventional power source.
 13. This battery is prohibited for non-designated devices.
 14. Do not touch any kind of liquid waste or byproduct from batteries. If skin or clothes come in contact with these substances, please flush with water!
 15. Do not mix other types of batteries with lithium batteries.
 16. Do not exceed the specified charging time.
 17. Do not place the battery in a microwave or in areas of high pressure.
 18. Do not expose the battery to the sun.
 19. Do not use in environments with high static electricity (64V and above).
 20. Do not use or charge in temperatures below 0 °C and above 45 °C.
 21. If a newly purchased battery is used, leaking, possesses a bad smell or other abnormalities, return immediately to the vendor.
 22. Keep away from the reach of children.
 23. Use a dedicated battery charger and follow all charging requirements.
 24. Minors who use the battery and its dedicated unit must be supervised by an adult at all times.

Two Different Ways to Fly, Two Configurations

1. Aircraft + Mobile Device

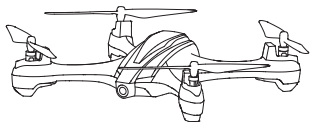

H507A



Mobile Device

2. Aircraft + HT009 Transmitter + Mobile Device (Phone/Tablet)

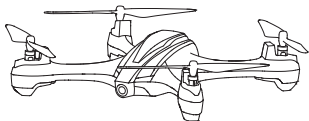

H507A

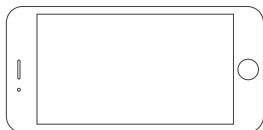

Mobile Device

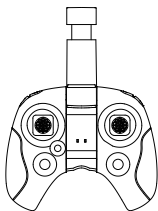

HT009

Table of Contents

Important Safety Information	1	4.3.2 Aircraft + HT009 Transmitter + Mobile Device (Phone/Tablet)	13
Symbol Explanation	1	4.4 Calibrations	14
Usage Advice	1	4.4.1 Compass Calibration	14
H507A Profile	5	4.4.2 Stick Settings	14
1. The H507A Aircraft	5	4.4.3 Horizontal calibration	14
1.1 Aircraft Component Breakdown	5	4.5 Flying with the APP	15
1.2 The Aircraft Battery	6	4.5.1 Arming/Disarming Motors	15
1.3 Installing and Removing the Propellers	6	4.5.2 Auto Takeoff/Land	15
1.4 Aircraft LED Indications	7	4.5.3 Advanced Functions	16
2. X-Hubsan APP	8	4.6 Flying with the HT009 Transmitter	17
2.1 Downloading the APP	8	5. Failsafe Modes	20
2.2 APP Interface Guide	9	5.1 Low Power Failsafe	20
3. The HT009 Remote Control/ Transmitter	9	5.2 Loss of Flight Control Connection Failsafe	20
3.1 HT009 Overview	9	Frequently Asked Questions	21
3.2 Transmitter Components and Functions	10	H507A Accessories	22
3.3 Battery installation	11		
4. Flight	11		
4.1 Flight Environment Requirements	11		
4.2 Pre-Flight Checklist	12		
4.3 Two Different Ways to Fly, Two Configurations	12		
4.3.1 Aircraft + Mobile Device	12		

H507A Overview

Thank you for purchasing a HUBSAN product. The H507A is an easy to fly aircraft, capable of a variety of flight functions.

Please read and follow the manual carefully for proper operation and use.

 FPV: Also known as First Person View, or the first person perspective. With FPV, users can intuitively fly the aircraft and enjoy an immersive flight experience.

1 The H507A Aircraft

1.1 Aircraft Component Breakdown

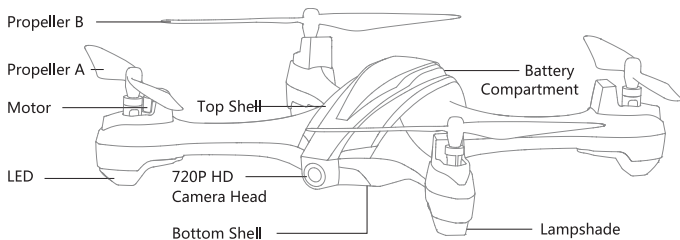

The aircraft supports Galileo, GLONASS, GPS, and supports up to three GNSS working simultaneously.

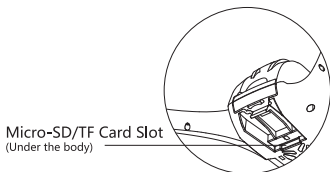

1.2 The Aircraft Battery

Charging: Connect the battery to the USB charger and connect the USB charger to a USB port or a smartphone adapter (5v, 1A or below). The USB charger LEDs are flashing red while charging and turn solid red when the battery is fully charged. Please disconnect the battery from the charger immediately afterwards. Full charging time is around 120 minutes.

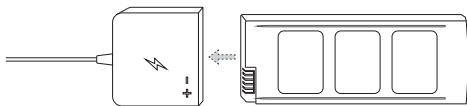

Installing the battery: Push the battery into its compartment, noting the positive and negative polarities.

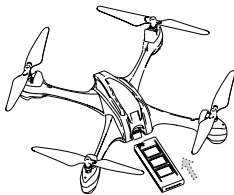

1.3 Installing and Removing the propellers

The X4 aircraft uses 5.3-inch propellers. Each is marked with either an A or a B. Please replace damaged propellers.

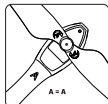
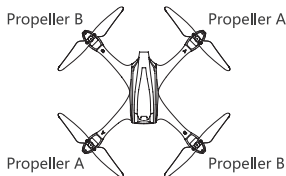

Tips:

Please be aware of the screw colors, match the corresponding screws and propellers.

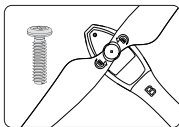

Propeller B

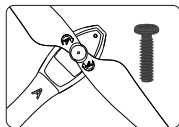

Propeller A

Before installing propellers, Align the "I" in a parallel fashion with the flat side of the "D" shaped motor shaft. Slide the propeller on and then use the provided screwdriver and screw to install each propeller. Propeller A's use black screws (counterclockwise); Propeller B's use silver screws (clockwise)

When the blade is damaged or needs to be replaced, use the screwdriver and remove A propellers by turning clockwise and B propellers by turning counter-clockwise

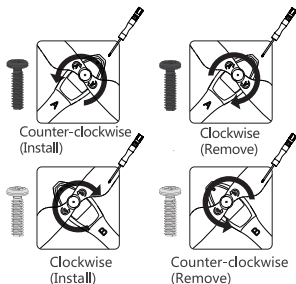
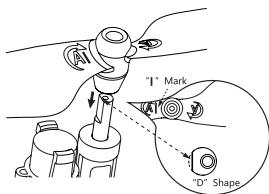

1.4 Aircraft LED Indications

H507A has 4 LEDs; the fore/frontal LEDs are blue and the rear LEDs are red. The LED status indications are defined as follows:

Function	LED Status Indication	
Power on and start up	All 4 LEDs flash slowly and simultaneously	
Compass Calibration	Horizontal Calibration	Calib. Compass 1, all 4 LEDs flash clockwise
	Vertical Calibration	Calib. Compass 2, LEDs should be flashing in vertical pairs, alternately
Horizontal Calibration	All 4 LEDs flash slowly and simultaneously	
Flight Mode	All 4 LEDs are solidly lit	
Return to Home	Fore/frontal blue LEDs stay solidly lit and the rear red LEDs flash slowly	
Low Power	Fore/frontal blue LEDs stay solidly lit and the rear red LEDs flash rapidly	
Headless mode	Fore LEDs slowly flash blue and rear LEDs are solid red.	
Flight Control Lost	When the flight control signal is lost, the rear LEDs will stay solid while the fore LEDs will flash	

2 X-Hubsan App

2.1 Downloading the APP

X-Hubsan is a flight control APP designed for HUBSAN WIFI-enabled aircraft. Users can control flight, camera, video and flight parameters with the APP. It is recommended to use a large screened smartphones or tablets for the optimal visual experience.

Download the APP for free by scanning the code on the right or by downloading it via the App Store (iOS) and Google Play (Android).



Scan to Download

2.2 APP Interface Guide

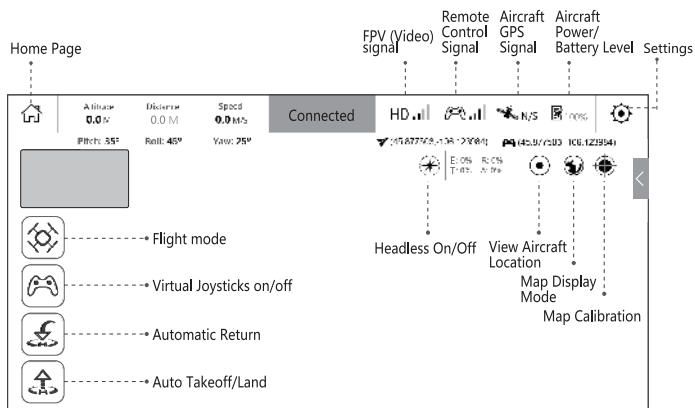

3 The HT009 Remote Control/Transmitter

3.1 HT009 overview

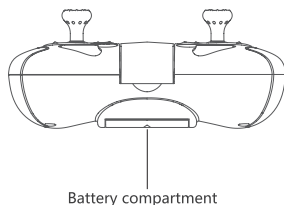
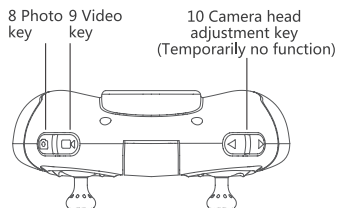

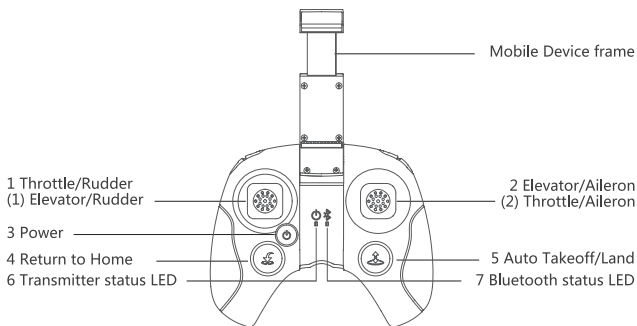

3.2 Transmitter Components and Functions

No.	Key/Button/Switch	Function
1	Throttle/Rudder stick	Push the stick forward or backward and the quadcopter will ascend or descend (respectively). Push the stick left or right and the quadcopter will rotate counterclockwise or clockwise (respectively).
2	Elevator/Aileron stick	Push the stick forward or backward and the quadcopter will fly forwards or backwards (respectively). Push the stick left or right and the quadcopter will fly left or right (respectively).
(1)	Throttle/Aileron stick	Push the stick forward or backward and the quadcopter will ascend or descend (respectively). Push the stick left or right and the quadcopter will fly left or right (respectively).
(2)	Elevator/Rudder stick	Push the stick forward or backward and the quadcopter will fly forwards or backwards (respectively). Push the stick left or right and the quadcopter will rotate counterclockwise or clockwise (respectively).
3	Power	Push the stick forward or backward and the quadcopter will fly forwards or backwards (respectively). Push the stick left or right and the quadcopter will rotate counterclockwise or clockwise (respectively).
4	Return to Home	Long press for 1.5 seconds and the quadcopter will perform a Return to Home. To terminate Return to Home, short press for 0.5 seconds.
5	Auto Takeoff/Auto Land	Long press for 1.5 seconds and the quadcopter will perform an Auto Takeoff or Auto Land (if the unit is airborne).
6	Transmitter status LED	When the transmitter is powered on, the LED should be solidly lit. If the transmitter is low on power, the LED will flash rapidly.
7	Bluetooth status LED	When the transmitter is powered on, the LED should be solidly lit. If the transmitter is low on power, the LED will flash rapidly.
8	Photo	Short press the key to take a photo
9	Video	Short press once to start the recording; short press again during the recording to stop the recording.
10	Camera head adjustment key	Temporarily no function.

3.3 Battery installation

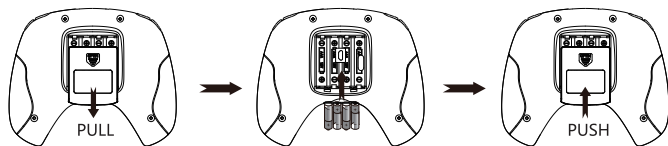

Remove the compartment screw. Slide open the compartment hatch.

Insert 4 AAA batteries into the battery compartment. Take note to make sure you have correctly matched the polarities.

Slide the compartment hatch to close it; screw it shut.



- Do not mix new and old batteries
- Do not cross-use different types of batteries at the same time
- There are two ports located in the battery compartment, used for upgrades. Please **DO NOT** use or connect these ports to any kind of device whatsoever!

4 Flight

4.1 Flight Environment Requirements

- (1) Select an open environment devoid of high rise buildings and tall obstructions (such as trees and poles). Near buildings and obstacles, flight control signals and GPS signals can be severely weakened; GPS functions such as GPS mode and Return to Home may not function properly.
- (2) Do not fly in bad weather conditions (such as in wind, rain or fog).
- (3) Fly the drone in ambient temperatures of 0-40 °C.
- (4) When flying, please stay away from obstructions, crowds, high voltage lines, trees, water, etc.
- (5) To avoid remote control signals interference, do not fly in complex electromagnetic environments (such as venues with radio stations, power plants and towers).
- (6) The H501A cannot be used in/near the Arctic circle or Antarctica.
- (7) Do not fly in no fly zones.
- (8) Do not operate the aircraft near high pressure lines,

4.2 Pre-Flight checklist

- (1) Make sure the aircraft battery and mobile device are charged and have adequate power
- (2) Confirm that propellers are properly installed
- (3) If you are taking pictures, insert the Micro-SD card required for taking pictures and videos (recommended Class 10, 16GB, 32GB max)
- (4) Verify that the motors arm and spin smoothly
- (5) Ensure the camera lens is clean

4.3 Two ways to pair and fly

4.3.1 Pairing the aircraft + mobile device

Connect the aircraft to the mobile device

- (1) Install the battery then power on the quad (hold down the power button until all four LEDs power on);

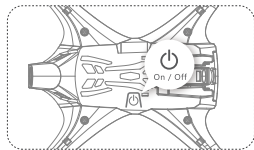

- (2) Connect the aircraft to the WIFI on the mobile device, then run X-Hubsan App.

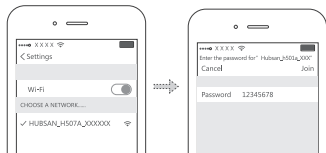

Name: Hubsan_H507A_XXXXXX Password: 12345678

4.3.2 Pairing the aircraft + mobile device + HT009 Transmitter

- (1) Power on the aircraft, and connect the aircraft to the WIFI on the mobile device, then run X-Hubsan App.
- (2) Power the transmitter on; pair the mobile device and transmitter on the Bluetooth menu.

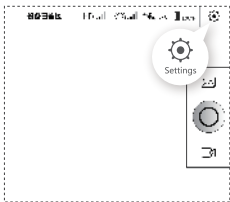

1. Enter the main app interface and tap the Settings cog on the upper right-hand corner.

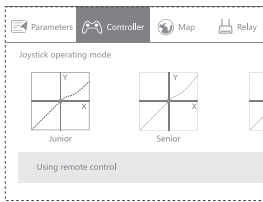

2. Tap "Controller" and then "Using remote control" .

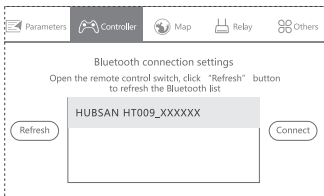

4. The interface will then show the "Bluetooth connection settings" menu. Select the HUBSAN HT009_XXXXXX and confirm to connect.

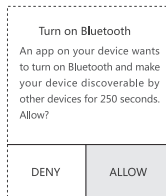

3. The device will request permission to use Bluetooth. Tap "Allow" to continue.

If the Bluetooth connection was successful, the display will show " Bluetooth connection is successful", then the Bluetooth LED on the HT009 transmitter will light up and make a "beep" sound.

4.4 Calibrations

4.4.1 Horizontal calibration

When the app interface shows the figures below, a compass calibration is needed. The compass is susceptible to interference by other electronic equipment, magnetic interference and metal, which can lead to erratic behavior and loss of control. Regular calibration helps keep the compass and its readings accurate.

- (1). Please follow the directions on the screen;
- (2). After completing the two operations, the calibration icons will disappear.

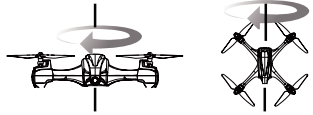

4.4.2 Stick Settings

To change stick settings: Open the main app interface, then tap on the "Settings" cog and followed by "Transmitter" tab.

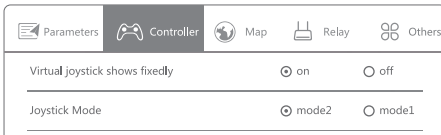

4.4.3 Horizontal Calibration

If during takeoff or flight the aircraft drifts, lifts off unevenly, perform a horizontal calibration. First, land the aircraft if it is flying and make sure all motors come to a complete stop. The aircraft must also be on a completely flat and horizontal surface for the calibration to work properly. Tap the Settings cog, followed by "Other". Select "Horizontal Calibration" and allow the aircraft to calibrate itself. Calibration is complete when all 4 LED indicators stop flashing. It is recommended that users wait for 15-20 seconds after the calibration is completed before flying again.

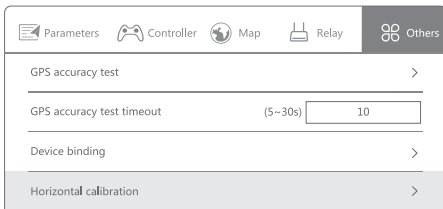

4.5 Flying with the APP

4.5.1 Arming/Disarming

How to arm (start) motors:

Simultaneously pull the virtual joysticks diagonally down-out to arm the motors (as shown in the below figure).

How to disarm (stop) motors:

Disarm the motors by simultaneously pulling both sticks diagonally down-out. When the motors have completely stopped, release the joysticks.

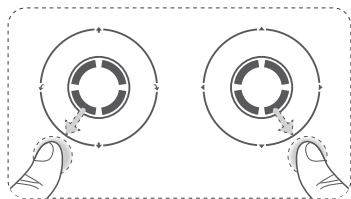

- ⊘ While flying, please make sure you do not disarm while in midair. The aircraft motors will stop, causing the aircraft to crash.
- 💡 Be sure to operate the virtual joysticks slowly and firmly. When disarming, wait until the motors come to a complete stop before releasing the joysticks.

4.5.2 Auto Takeoff/Land

When the aircraft's LEDs are solid and the aircraft is ready for flight, pilots may use the Auto Takeoff/Auto Land features. Please follow the below steps:

Auto Takeoff:

First, confirm that take-off conditions are safe and clear. Tap the Auto Takeoff icon; the aircraft will automatically takeoff and hover at a height of ~2 meters from the ground. Note that the Auto Takeoff icon will turn into an Auto Land icon after the aircraft begins to fly.

Auto Land:

First, confirm that landing conditions are safe and clear. Be sure to choose a flat, open area for the landing. Tap the Auto Land icon; the aircraft will slowly descend to the ground and disarm its motors.

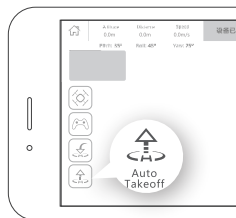

4.5.3 Advanced Functions

Headless Mode

Tap the compass icon to activate Headless mode. The aircraft will set the direction its head is pointing at the time of activation as the default "forward" direction in Headless mode.

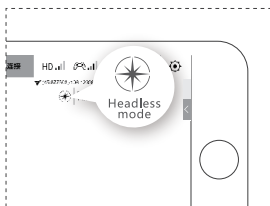

Waypoint Mode

While motors are completely disarmed, tap the Flight mode icon and select the Waypoint mode icon. You can custom set each Waypoint altitude, travel speed and other parameters before uploading your Waypoint mission. After takeoff, the aircraft will fly its specified route.

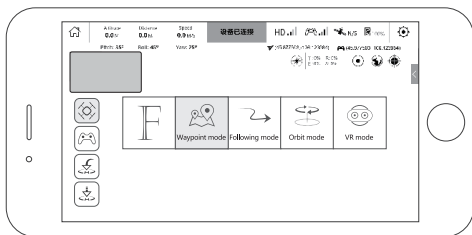

Tap Flight mode icon and select Follow Me. The aircraft will now follow the mobile device. Pilots may adjust the following distance with the elevator stick (back and forth only) while the aircraft is in Follow Me mode.

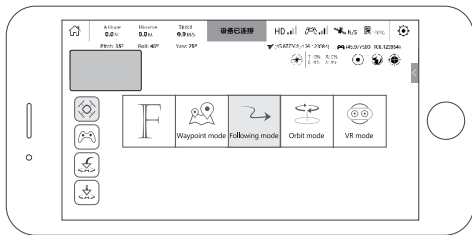

Circle Fly/Orbit Mode

Tap the Flight mode icon and select Orbit/Circle fly. The aircraft will fly in a circle around the mobile device. Orbit is only usable when the aircraft is at least 3 meters away from the mobile device. While in Orbit, pilots may use the aileron (left and right only) to adjust the Orbit radius.

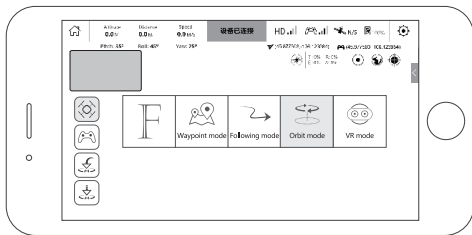

Please begin flight only when you have 6 or more GPS satellites. Waypoint/Return to Home/Orbiting/Follow Me modes are then accessible. Note: GPS cannot be accessed indoors.

4.6 Flying with the HT009 Transmitter

When the HT009 is successfully paired with a mobile device and the aircraft, pilots may use it to control the H501M.

How to arm (start) motors:

Simultaneously pull both joysticks diagonally down-out as shown in the right hand figure.

How to disarm (stop) motors:

Make sure the aircraft has completed its descent to the ground.

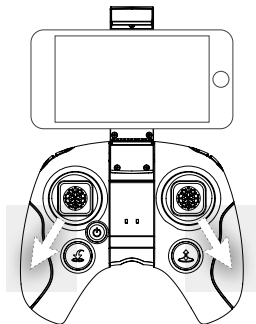

While flying, please make sure you do not disarm while in midair. The aircraft motors will stop, causing the aircraft to crash.



Be sure to operate the virtual joysticks slowly and firmly. When disarming, wait until the motors come to a complete stop before releasing the joysticks.

Auto Takeoff/Land

When the aircraft's LEDs are solid and the aircraft is ready for flight, pilots may use the Auto Takeoff/Auto Land features. Please follow the below steps:

Auto Takeoff:

First, confirm that take-off conditions are safe and clear. Tap the Auto Takeoff key; the aircraft will automatically takeoff and hover at a height of ~2 meters from the ground. Note that the Auto Takeoff key will turn into an Auto Land key after the aircraft begins to fly.

Auto Land:

First, confirm that landing conditions are safe and clear. Be sure to choose a flat, open area for the landing. Tap the Auto Land icon; the aircraft will slowly descend to the ground and disarm its motors.

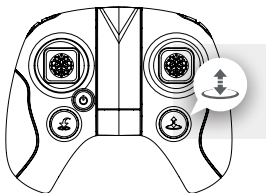

Return to Home

Return to Home mode will only work when the aircraft has 6 or more satellites. Otherwise, the unit will not be able to return and will malfunction. Otherwise, the unit will not be able to return and will malfunction. Otherwise, the unit will not be able to return and will malfunction.

Return to Home

Entering Return to Home mode

Long press the Return to Home button for 1.5 seconds and the quadcopter will perform a Return to Home. The flight control system will command the aircraft to return to its designated "home" point. Users can either allow the flight system to land the aircraft automatically, or exit Return to Home and land the aircraft manually.

Exiting Return to Home



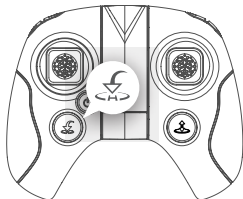



To terminate Return to Home, short press for 0.5 seconds. Users may then continue to fly or land the aircraft manually.

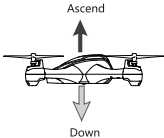

Use this function only if the aircraft has 6 or more GPS satellites.

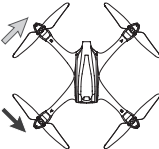
The remote control is by default set to Mode 2 in factory; this manual will introduce flight operations in Mode 2.

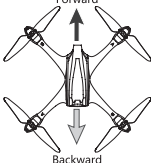
- Transmitter joysticks are self-centering and spring loaded: the joysticks will automatically center themselves
- Joystick sensitivity: dependent how much and how forcefully each joystick is pulled or pushed away from center point

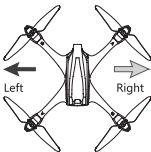
Remote Control (Mode 2)	Aircraft	Transmitter Controls
	<p>Ascend</p>  <p>Down</p>	<p>The throttle is used to control the ascent and descent of the aircraft. Push the throttle up and the aircraft ascends. Pull the throttle back and the aircraft descends. When the joystick is centered (unmoving), the aircraft will hold its altitude in the air. The throttle must be pushed upwards beyond center point for the aircraft to completely takeoff from the ground. The harder the throttle is pushed, the faster the aircraft will ascend. Please push the throttle slowly for a gradual lift and to prevent the aircraft from ascending erratically.</p>
	<p>Clockwise rotation</p>  <p>Counterclockwise rotation</p>	<p>The rudder is used to control the aircraft's rotations. Push the joystick to the left and the aircraft rotates counterclockwise. Push the joystick to the right and the aircraft rotates clockwise. When the joystick is centered (unmoving), the angular velocity of the aircraft is "0" and the aircraft will not turn. How hard the rudder is pushed will determine the angular velocity of the aircraft's rotation. The harder the rudder is pushed, the faster the aircraft rotates.</p>
	<p>Forward</p>  <p>Backward</p>	<p>The elevator controls the aircraft's forward and backward movement. Push the joystick forward and the aircraft will tilt and fly forward. Pull the joystick back and the aircraft will tilt and fly backwards. When the joystick is centered (unmoving), the aircraft will hold its altitude in the air. How hard the elevator is pushed will determine the degree of the aircraft's tilt and therefore the velocity of its forward and backward movement. The harder the elevator is pushed, the greater the aircraft's tilt angle and flight speed either forwards or backwards.</p>
	<p>Left</p>  <p>Right</p>	<p>The aileron controls the aircraft's left and right movement. Push the joystick to the left and the aircraft will tilt and fly leftwards. Pull the joystick to the right and the aircraft will tilt and fly rightwards. When the joystick is centered (unmoving), the aircraft will hold its altitude in the air. How hard the aileron is pushed will determine the degree of the aircraft's tilt and therefore the velocity of its left and right movement. The harder the aileron is pushed, the greater the aircraft's tilt angle and flight speed either leftwards or rightwards.</p>

5 Failsafe Modes

5.1 Low Power Failsafe

When the aircraft battery is low, there is likely insufficient power to support the return of the aircraft. Please land the aircraft immediately, otherwise the aircraft will fall and cause damage to the aircraft and surrounding objects. To prevent this, the aircraft flight control will use flight information to determine whether to perform a Return to Home or to land immediately.

5.2 Loss of Flight Control Connection

where the remote control/transmitter was last located and land there. This can drastically reduce the possibility of the aircraft crashing or being lost.

Conditions that may trigger a failsafe

- (1) Transmitter is powered off/loses power.
- (2) The flight distance exceeds the remote control's signal transmission range.
- (3) There is an obstacle between the remote control and aircraft.
- (4) The flight control or transmitter signal is interrupted by strong external electronic interference.



To ensure the successful return of the aircraft if it loses flight control connection, users must confirm that the aircraft has enough GPS satellites to fly safely in GPS mode. Users must also be certain that the flight environment is clear enough for an emergency return and landing.

-If the aircraft's GPS satellites drop below 6 for more than 20 seconds while the X4 is returning to Home Point, the aircraft will automatically descend.

Frequently Asked Questions

1. Aircraft and remote control are not pairing

- ① Check that the mobile device WIFI utility is active.
- ② Check that the mobile device WIFI utility is active.

2. Weak or nonexistent GPS signal/few or no GPS satellites

Make sure that the aircraft is not indoors or between buildings. Please take the aircraft outdoors to receive GPS satellites/signal.

3. Follow Me mode does not work

- ① Check that the aircraft is in GPS Hold mode (Follow Me will not work without it)
- ② Check that the aircraft has 6 or more satellites (Follow Me will not work otherwise)
- ③ See if the aircraft power is dipping below 25% (Follow Me will not function if so)

4. The aircraft does not return to the home point

When the aircraft takes off, be sure that the aircraft has received 6 or more satellites.

5. The aircraft keeps on losing GPS satellites or GPS satellites drop to 0 erratically

Check to see whether there are sources of high-frequency signal interference around the aircraft (such as high-voltage lines, signal transmission towers, etc).

6. Aircraft/video feed is shaking/shaky

- ① Check if the aircraft propellers are deformed or broken. Please replace them.
- ② Check that all aircraft body screws are firmly in place.
- ③ Check whether any motor shafts are broken. Motors must be replaced if the shafts are broken.

7. Aircraft refuses to pass the GPS accuracy test (even after a long wait)

- ① Restart the test from the Settings interface ("Other") and move the mobile device around the drone (you must be within 1-3 feet of the aircraft for this to work)
- ② Rebind/re-pair the mobile device and aircraft

H507A Accessories



H507A-01
Body Shell



H507A-02
Lamp Base A/B (Yellow)



H502C-02
Lamp Base A/B (Grey)

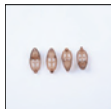

H507D-02
Lamp Base A/B (Brown)



H502C-03
Screw Set

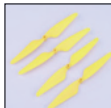

H507A-03
Propellers A/B (Yellow)



H502S-03
Propellers A/B (White)



H502E-03
Propellers A/B (Red)



H507D-03
Propellers A/B (Orange)



H502-05
Motor A



H502-06
Motor B



H507A-04
Motor Holder (Grey)



H502-07
Motor Holder



H502-08
Bearing



H502-10
Motor Gear B



H502-11
Transmission Shafts



H502-12
LED Kit



H507A-05
Flight Control PCBA



H507A-06
Camera Module 720P

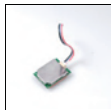

H507A-08
GPS Module

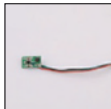

H501S-13
Compass Module



H507A-07
Aircraft Battery



H507A-09
USB Charger



H502-19
Screwdrivers



H502-20
Propeller Guard



H501A-04
HT005 Relay

Disclaimer & Warning

Hubsan accepts no liability for damages, injuries or any legal responsibilities incurred directly or indirectly from the use of Hubsan products under the following conditions:

1. Damages, injuries or any legal responsibilities incurred when users are drunk, under the influence of drugs or anesthesia, dizzy, fatigued, nauseous and/or affected by other conditions both physical and mental that could impair sound judgment and/or personal ability.
2. Subjective misjudgment and/or intentional mis-operation of products.
3. Any and all mental damage, trauma, impairment, illness, compensation caused/solicited by accidents involving Hubsan products.
4. Product operation in no-fly zones (i.e. natural reserves).
5. Malfunctions or problems caused by modification, refit, replacement or use with non-Hubsan accessories/parts, failure to follow the guidance of the manual in assembly or operation.
6. Damages, injuries or any legal responsibilities caused by mechanical failures due to natural wear and tear (aircraft flight time docking in 100 hours or above), corrosion, aging hardware, etc.
7. Continued flight after low voltage protection alarms are triggered.
8. Knowingly flying aircraft under abnormal conditions (such as when water, oil, soil, sand or other unknown material are inside the X4, the aircraft and/or transmitter are incompletely assembled, the main components have obvious faults, obvious defect or missing accessories, etc).
9. Flying in the following situations and/or environments: areas with magnetic interference (such as high voltage lines, power stations, broadcasting towers and mobile base stations), radio interference, government regulated no-fly zones, if the pilot loses sight of the X4, suffers from poor eyesight or is otherwise unsuited for operating Hubsan products.
10. Aircraft use in or exposure to bad weather, such as a rain, wind, snow, hail, lighting, tornadoes and hurricanes.
11. Products are involved in/exposed to collisions, fire, explosions, floods, tsunamis, manmade and/or natural structure collapses, ice, avalanches, debris, landslides, earthquakes, etc.
12. The acquisition, through use of Hubsan products (specifically but not limited to aircraft), of any data, audio, video that results in infringement of law and/or rights.
13. Misuse and/or alteration of batteries, product/aircraft circuits, hardware protections (including protection circuits), RC model and battery chargers.
14. Any malfunction of equipment or accessory, including memory cards, that results in the failure of an image or video to be recorded or to be recorded in a way that is machine readable.
15. Users who engage in reckless, unsafe flying (with or without sufficient training).
16. Noncompliance with precautions, instructions, information and operation guidelines/methods given through official Hubsan website announcements, product quick start guides, user manuals, etc.
17. Other losses, damages, or injuries that are not within the boundaries of Hubsan responsibility.

Advisory

1. This product complies with FCC RF radiation exposure limits set forth for an uncontrolled environment. This product also complies with Part 15 of the FCC rules.

Operation is subject to the following two conditions:

(1) This device may not cause harmful interference.

(2) This device must accept any interference received, including interference that may cause undesired operation.

NOTE: The manufacturer is not responsible for any radio or TV interference caused by unauthorized modifications or changes to the X4. Such modifications or changes could void the user's authority to operate the product.

NOTE: This equipment has been tested and found to comply with the limits for a Class B digital device, pursuant to Part 15 of the FCC rules.

These limits are designed to provide reasonable protection against harmful interference in a residential installation. This equipment generates, uses and can radiate radio frequency energy.

If not installed and used in accordance with the instructions, it may cause harmful interference to radio communications. However, there is no guarantee that interference will not occur in a particular installation. If this equipment does cause harmful interference to radio or television reception (which can be determined by turning the equipment off and on) the user is encouraged to try to correct the interference with one or more of the following measures:

·√ Reorient or relocate the receiving antenna.

·√ Increase the distance between the aircraft and transmitter.

·√ Consult the product dealer or an experienced radio/TV technician for help.

2. Make sure that antennas are at least 20 cm away from people. The internal remote control USB interface and aircraft USB interface can only be connected using USB 2.0 and above. Do not connect to a USB power connector. Please use correct batteries, as the use of other types puts the device at risk of exploding. Follow guidelines for handling used batteries correctly. Hubsan guarantees that this product meets basic 19991/EC requirements, as well as some other relevant directives.

Please note that this product is intended for personal use and should never be used in a manner that infringes upon or contravenes international or domestic law and regulations.

You shall not use Hubsan products to:

1) Defame, abuse, harass, stalk, threaten or otherwise violate the legal rights (such as right of privacy and publicity) of others.

2) Photograph people on private property without their consent or photograph in areas where photography is prohibited without prior authorization.

3) Use Hubsan products for illegal or inappropriate purposes (such as for espionage, military operation, unauthorized investigation and unauthorized detection).

social habits.

4) Violate or disregard applicable laws, administrative rules and social customs.

Please note:

- 1) Filming or recording shows, exhibitions or other commercial buildings for private purposes may in some cases result in the infringement of intellectual property rights.
- 2) In some regions and countries, small aerial photography aircraft are prohibited from engaging in commercial activities.

If you encounter any problems that you can not resolve during the installation process, please contact an official distributor or Hubsan Technical Support. All intellectual property rights/copyrights of this product and its manual are owned by Shenzhen Hubsan Science and Technology Co., Ltd. No organization or individual may reprint, duplicate or publish in any form without prior written permission. If quoted or published, it shall be indicated that the source is Shenzhen Hubsan Science and Technology Co., Ltd., and shall not be inconsistent with the original source for reference, deletion and modification.

Please read the operating instructions carefully before use!



- Never leave units unattended when charging
- Unplug the charging cable immediately after charging
- Propellers may cause injury
- This product is not a toy and is not suitable for children under 14 years of age

WWW.HUBSAN.COM

Product name: X4 Air Basic Edition
Product Standard Number:Q/HBS 001-2017
Vendor: Shenzhen Hubsan Technology Co., Ltd
Address: 13th Floor, Block C, Shenzhen Software
IndustrialBase, Xuefu Road, Nanshan District, Shenzhen,
Guangdong Province, China
Email: service@hubsan.com