

# SUPER YOTER R THERMAL SIGHT (BE43045L)

## Instruction manual



Product image

### PRODUCT OVERVIEW

The Bering Optics SUPER YOTER R 3.0-12.0x50mm Compact Thermal Weapon Sight features the advanced 12 $\mu$ m Vanadium Oxide (VOx) 640x480 core resolution with 50Hz refresh rate that makes the scope ideal for predator control at medium- and long-range distances. This Thermal Scope has an optical magnification of 3.0x and digital zoom of 2X, 3X, 4X.

The wide range of controls and capabilities allow the user to adapt the scope to various conditions and personal preferences. There are 8 reticle patterns including 3 BDC reticles, along with four color options for each reticle pattern. The sight operation is controlled with three buttons allowing easy selection of the options.

A unique adjustable stradiametric rangefinder can be set to the height of the animals, thus increasing the overall usefulness of this feature. Other useful features of the Super Yoter R is a wide selection of the image adjustment options as well as the image background adjustment and calibration.

### FEATURES

- Superior for predator control at medium- and long-range distances
- Excellent performer in high humidity conditions
- Picture-in-Picture function- 2X multiplied image on a top of the display
- Automatic shutter based thermal VOx core with Auto- or Manual calibration
- Switchable image polarity: White Hot / Black Hot / Red Hot / Colored Hot
- 8 reticle patterns including 3 BDC reticles
- 4 color options for each reticle pattern
- Precise W/E adjustment increments is 0.54" at 1X (3.0x native magnification) and just 0.14" at 4X multiplied image
- Manual control of the image sharpness and screen brightness
- Manual control of the contrast
- Manual control of the image background balance of white (Cool or Warm)
- Ability to save 4 profiles of zeroing calibration data
- Stradiametric Rangefinder function to estimate the distance to the targets; Manually adjustable target's height
- A precise lens focusing mechanism
- 5V DC external power supply option via a Type-C USB port
- Blind Pixel repair tool
- Standby mode
- Digital Compass
- Inclinometer
- Battery status indicator
- Nitrogen purged
- Video out
- 32Gb internal memory
- Built-in internal recording function in .mp4 (video) and .jpeg (image) formats
- Wi-Fi capable- allows media recording to the mobile device (iOS or Android App is required)
- Equipped with the LaRue Tactical® Quick-Detach (QD) lockable mount

## KIT INCLUDES

SUPER YOTER R Thermal Weapon Sight  
Quick-Detach (QD) lockable mount  
Front lens protective cap  
Rubber eye guard  
2 CR123 batteries  
Type-C USB cable  
Soft Carrying Case with a shoulder strap  
Lens Cleaning Cloth  
Instruction manual

## SPECIFICATIONS

Optical Magnification, x	3.0
Digital Multiplication	2X, 3X, 4X
Objective Lens system	50mm F/1.0
Angular FOV at Optical Magnification (Horizontal x Vertical), degrees	H8.5° x V6.4°
Linear FOV at Optical Magnification @ 100yds/90m (Horizontal x Vertical), yd/m	H <u>15</u> /13.7 x V <u>11.2</u> /10.2
Eye relief, mm	46.6
Focus range, yard	0.8 to infinity
Diopter Adjustment, D	-5; +5
Reticle W/E adjustment value at a distance of 100m, in/cm	0.54" at 1X (3.0x magnification) 0.14" at 4X multiplication
Core resolution, pxl	640x480
Pixel pitch, µm	12
Start-up time, min., sec.	20
Image refresh rate, Hz	50
Thermal Sensitivity (NETD), mK	≤40
Display type and resolution, pxl	OLED 1024x768
Detection Range, (6 ft tall target), approx., yd/m	2200 / 2000
Dimensions, in/mm	<u>8.46"x3.15"x2.36"</u> / 215x80x60
Weight w/out batteries, but with QD mount, eye cup & lens cover, oz/g	20 / 570
Power supply	3V CR123 (two) or 3.7V rechargeable (two) or 5V DC (USB C-type)
Estimated battery life, hours	3.5 from two 3V CR123
Operating temperature, typical, °F	-14°F to +122°F
Water intrusion	IP66
Humidity, %	up to 96%

## ATTENTION!

For the most optimal user experience, please read this manual thoroughly before operating this device. And keep this manual in a safe place for future reference.

## WARNINGS AND CAUTIONS

This device contains highly specialized and sensitive internal electronics. Handle with care. This device contains no operator serviceable components. Contact Bering Optics customer support if you cannot diagnose an issue. Disassembling the device WILL void the warranty.

**WARNING** Ensure that the device is powered off before installing or removing batteries. Failure to do so could result in the damage sensitive internal electronics.

**WARNING** Do not mix rechargeable and non-rechargeable CR123 batteries.

**CAUTION** Do not store the device with the batteries installed.

**WARNING** Do not disassemble, puncture, recharge, or expose the battery to fire or high temperature. Doing so may result in an explosion and chemical burns. When the device is not in operation for a prolonged period, remove the battery from the device and keep it separately in a cool and dry place.

**WARNING** Do not operate in a potentially explosive environment, near gasoline fumes or other volatile materials. This is a high voltage electrical device.

**WARNING** Do not aim this device at the high-intensity sources like the sun, flame etc. This may damage the product.

**WARNING** Avoid direct sun beams through the eyepiece. It can burn and damage the device detector.

**WARNING** Use of Thermal vision attachments or riflescopes on a rifle may be restricted or prohibited by national or local regulations. Please consult with local authorities as to whether you are allowed using the night vision attachment on your weapon legally in your area.

**WARNING** Avoid exposure to water — even though the device is water resistant, excessive exposure could damage the electronics.

**CAUTION** Presence of one or several segments (spots, stripes) of a brighter or darker gradation in the field of view is normal. The segments often appear in cases of large temperature difference between the observer's location and surrounding space (for example, viewing from a warm room through an open window).

**NOTE** Failure to observe warnings, product use instructions and storage recommendations may void the warranty.

## PARTS IDENTIFICATION AND OPERATING CONTROLS



1. Objective Lens
2. Objective Lens Focus Ring
3. Power ON/OFF button
4. Menu ("M") button
5. Calibration/Photo/Video button
6. USB C-type Interface port (lift the flap)
7. Eye Piece Diopter Adjustment Ring
8. Rubber Eye Guard
9. Objective Lens Protective Cap
10. Tools Less nut
11. Battery Compartment Lid
12. Battery Compartment Cover Thumb Screw
13. LaRue Tactical® QD Picatinny mount
14. Tactical QD mount Sliding Lock
15. Tactical QD mount Locking Lever

Image 1

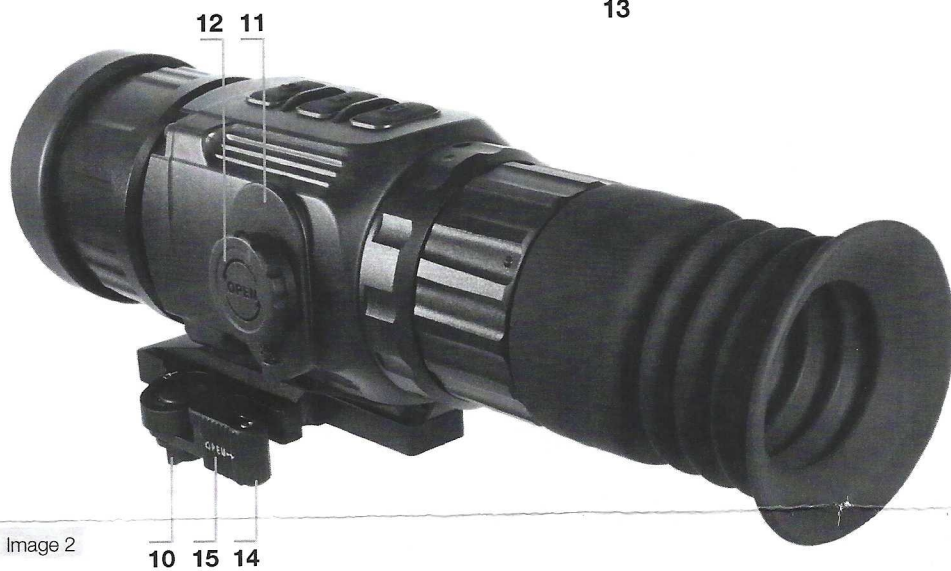



Image 2

## BATTERY INSTALLATION

- Open the Battery Compartment Lid (11) by twisting the Battery Compartment Thumb Screw (12) counter clockwise (there is a directional arrow located on the lid). The Battery Compartment Lid will pop up.
- Inspect the battery compartment for any debris, corrosion and/or moisture.
- Insert batteries observing the respective battery polarity diagrams located inside the battery compartment.
- Replace the Battery Compartment Lid (11) by aligning the lid in the original position and firmly pressing it down.

**NOTE:** The battery compartment lid has two latches. When close the lid by pressing it down, there shall be two audible clicks. The properly closed lid shall have no gaps, no rubber O-ring shall be visible; it shall be fully sealed. Inspect the battery compartment lid when experiencing an unexplained powering off. If there is a gap, then the lid is not closed properly allowing batteries to push it up. Follow these instructions and properly close the battery compartment lid.

- The battery capacity indicator is located in the upper right corner of the screen. The icon  with a tiny red line indicates the remaining battery capacity of less than 30 minutes. Be prepared to change batteries.

**ATTENTION:** To use rechargeable batteries, select 3.7V battery type in the ADVANCED SETTINGS MENU. Please refer to ADVANCED MENU SETTINGS section for instructions.

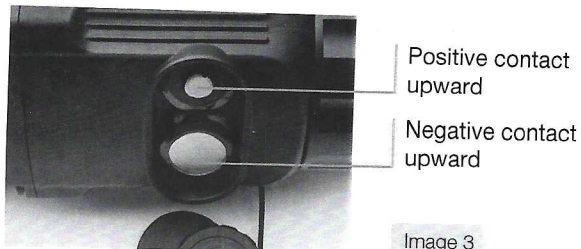

Image 3

**NOTE:** Low battery can cause the viewed image distortion. Pay attention to the low battery indicator and timely replace the batteries.

**CAUTION:** The use of rechargeable 3.7V accumulators, contents a risk of the scope damage due to inconsistent quality and overvoltage capacity. When use rechargeable batteries, check voltage of the fully charged batteries to ensure they give proper voltage not exceeding 3.7V.

**WARNING** The manufacturer's warranty is void when the scope damage was caused by the improper rechargeable batteries.

**WARNING DANGER OF EXPLOSION** Lithium batteries contain sulfur dioxide gas under pressure and should be handled in the following manner:

- Do not attempt to heat, puncture, disassemble, short circuit, recharge, or otherwise tamper with the batteries.
- Turn OFF the device if the battery compartment becomes unusually hot. If possible, wait until the battery has cooled before removing them.
- The batteries have safety vents to prevent an explosion. When they are venting gas, you will smell it (very irritating) or hear the sound of gas escaping. After engagement of the safety vents, the batteries are fairly safe from bursting, but will be hot, therefore must be handled with care.
- Do not carry batteries in pockets containing metal objects such as coins, keys and etc. Metal objects can cause batteries to short circuit and become very hot.
- Do not mix rechargeable and non rechargeable CR123.

## MOUNTING

The Bering Optics SUPER YOTER R 3.0-12.0x50mm Compact Thermal Weapon Sight is assembled with the LaRue Tactical® QD mount. For the best experience, please review the Tool Less Lever System insert supplied by LaRue Tactical® that is enclosed with your Super Yoter.

The tension of the Locking Lever (15) is adjustable with a very slight turn of the Tool Less nut (10). The nut requires only slight movement to adjust tension. Turning the nut (10) clockwise makes it more difficult to remove the mount. Turning the nut counterclockwise makes removal easier.

**NOTE** The Tool Less Nut is not removable.

- To open the Tactical QD Sliding Lock (14), pull it in the direction of the arrow that is placed on the lock. Then pull the Tactical QD Locking Lever (15) to the open position as shown in Image 4.
- If needed, adjust the tension on the Locking lever (15) using the Tool Less Nut (10). To finish, close the Locking Lever (15) as shown in Image 5.
- To close the Tactical QR Sliding Lock (14) slide it back in the original position
- Once the LaRue Tactical® QD mount (13) has been set up to fit the rail properly, mount the SUPER YOTER for the most comfortable eye relief.

**NOTE** If mounting on a "heavy-recoil" rifle, for safety purposes, allow at least .5" or more additional eye relief.

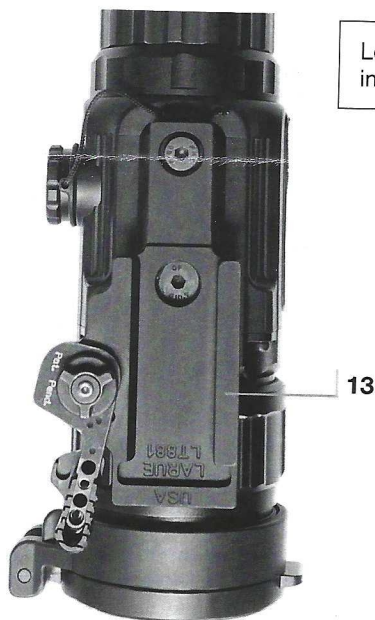

Image 4

Lever shown  
in OPEN position

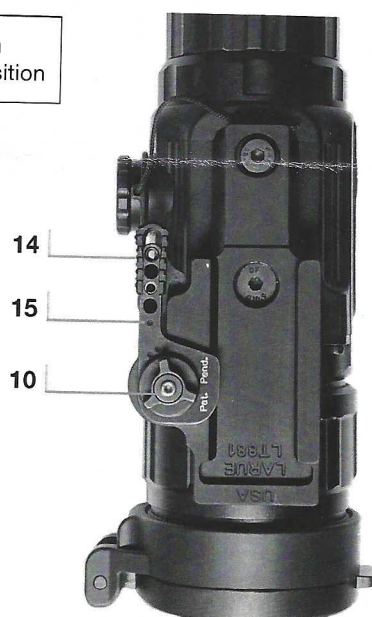

Image 5

Lever shown  
in CLOSED position

**CAUTION** Improper installation of after-market mounting hardware can lead to permanent damage and/or affect the sight ability to hold zero. Damages to the sight housing that resulted from the original mount removal or from the new mount installation are not covered by the Bering Optics warranty as well as zeroing issues that might stem from that after-market mount.

## OPERATION

**CAUTION** When use the device as a hand-held unit, carrying it or placing it in the upright position, avoid direct sun light beams through the eye piece. It can melt internal parts and damage the device detector.

### TO TURN ON/OFF

- Install the batteries per the BATTERY INSTALATION instructions. Open the objective lens protective cap (9).
- To turn ON, press and hold the POWER button (3) for about 3 seconds. The shutter will click a few times followed by the Bering Optics start up logo shown momentarily on the display before showing the thermal image.
- To turn OFF, press and hold the POWER button (3) for about 3 seconds until the shutdown menu pictogram (Image 9) appears on the display. Select "√" using the POWER button (3) or the CALIBRATION button (5), then short press the "M" button (4) to power off the sight. To exit the shutdown menu, select "X" using the POWER button (3) or the CALIBRATION button (5), then quick press the "M" button (4) to confirm the selectin and exit.

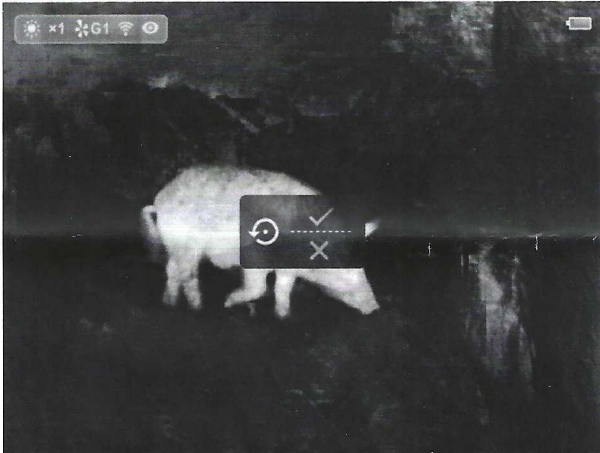

- Use the USB C-type cable (19) to connect the scope to the external power supply source. A connector icon will appear in the upper right corner of the screen, indicating that the scope is powered by an external power source. To turn off, follow the above described procedure or, alternatively, simply unplug the USB cable from the scope USB C-type port (6). Image shows SUPER YOTER connected to the external power supply using the USB cable (19).

**NOTE** When the sight is powered by the external power source via the USB cable, the power supply is automatically switched from the batteries, located inside the battery compartment, to an external power source.

**ATTENTION:** 3.7V rechargeable batteries, located in the battery compartment, cannot be recharged by connecting the sight to the external power source via the USB connector.

Image 6

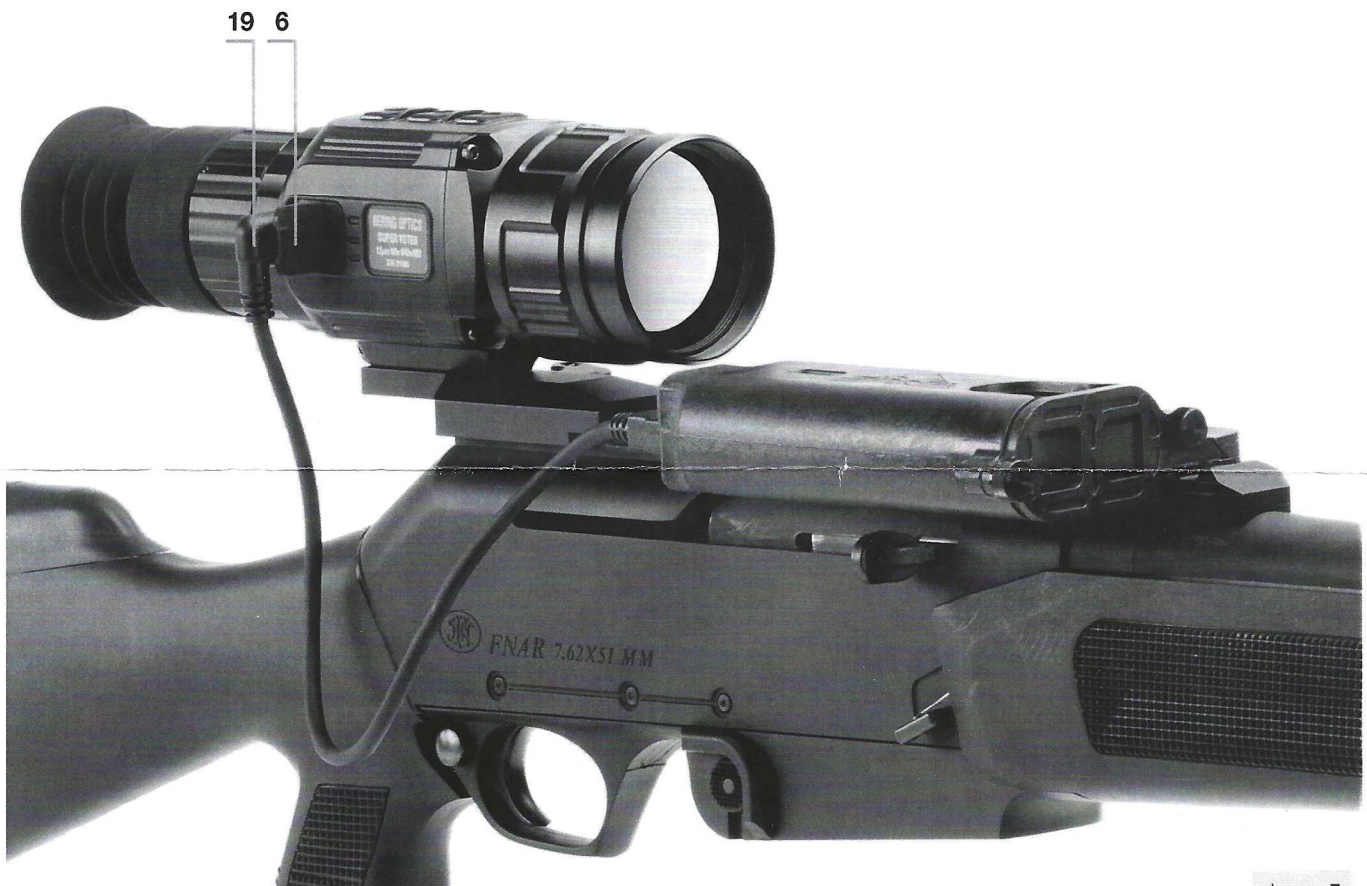

Image 7

### FOCUSING

- To adjust the eye piece focus, rotate the Eye Piece Diopter Adjustment Ring (7) of the Eye Piece until the pictograms and reticle displayed on the screen are sharp and clear.
- To adjust the optical focus, rotate the Objective Lens Focus Ring (2) until the observed image is sharp and clear.
- To focus at the object at different distances, it is sufficient to only adjust the Objective Lens Focus Ring (2).

**STANDBY MODE**

- To engage the standby mode, quick press POWER button (3) and MENU button (4). The screen will turn off.
- To exit the standby mode, quick press either POWER BUTTON (3), or MENU button (4) or CALIBRATION BUTTON (5). The scope will turn back ON, bypassing the start up screen with the logo.

**NOTE** In the standby mode the device uses about 15%-20% less power, however it still continues consuming the power.

**MANUAL CALIBRATION**

- To manually calibrate the shutter, simultaneously quick press the “M” MENU (3) and “C” CALIBRATION (5) buttons. There shall be an audible click sound.
- To calibrate the image background simultaneously press and hold the “M” MENU (3) and “C” CALIBRATION (5) buttons. The lens cap shall be closed to perform this operation.

**BUTTONS LAYOUT AND FUNCTIONALITY**

The SUPER YOTER buttons operate in 2 ways: Quick Press (Press/Release) and Long Press (Press/Hold for a few seconds).

**CAUTION:** Do not press device buttons with objects or using excessive force. This could damage the rubber coating as well as the button mechanisms. When Pressed properly, the buttons will give a tactile feedback, which feels like a click.



Image 8

**POWER** button (3): button with a power **ON/OFF** pictogram

**MENU** button (4): button with a letter **M**









**CALIBRATION/PHOTO/VIDEO** button (5): button with a pictogram of a camera

**IMAGE ADJUSTMENT MENU**

- Quick press the MENU button (4) to enter the IMAGE ADJUSTMENT MENU mode. Use quick menu to adjust the display and image brightness, polarity mode, image magnification, sharpness and contrast, and to select reticle pattern and its color.
- Quick press the MENU button (4) to cycle through the menu options and exit the menu. The menu options will cycle in the order shown in the below table, listing adjustment options on the top and bottom of the screen, correspondingly.
- Quick press the POWER button (3) to cycle through the sub-menu options, located on the top of the screen, and to make a selection. The selection will be highlighted in blue.
- Quick press the CALIBRATION button (5) to cycle through the sub-menu option, located on the bottom of the screen, and to make a selection. The selection will be highlighted in blue.

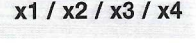
QUICK PRESS	TOP ROW OPTION	BOTTOM ROW OPTION
	Quick press POWER button (3) to scroll over selections	Quick press CALIBRATION button (5) to scroll over selections
1	Polarity Mode 	Display Brightness 
2	Image Magnification 	Image Sharpness 
3	Image Brightness 	Image Contrast 
4	Reticle Color 4 options	Reticle Pattern 8 options
5	Exit	













## IMAGE ADJUSTMENT MENU ICON CHART

	White Hot Polarity Mode
	Black Hot Polarity Mode
	Red Hot Polarity Mode
	Colored Hot Polarity Mode
	Image Multiplication settings ranging from native to x4
	Display brightness ranging from dimmest to brightest
	Image sharpness settings; select the most visually suitable for the given viewing conditions
	Image brightness; select the most optimal for the given viewing conditions
	Image contrast; select the most optimal for the given viewing conditions

## ADVANCED MENU SETTINGS

- Long press the MENU button (4) to enter the ADVANCED MENU SETTINGS. Please refer to the ADVANCED MENU OPTIONS CHART for the icon identification and additional details on the menu and sub-menu options.
- To scroll between the menu options, use the POWER button (3) to scroll upward, or CALIBRATION button (5) to scroll downward.
- Quick press the MENU button (4) to make a selection or to open a sub-menu. The selection will be highlighted in blue.
- Select the last menu icon on page one of the ADVANCED MENU and quick press the MENU button (4) to open the second page of the ADVANCED MENU settings.
- Long press the MENU button (4) to exit the sub-menu or ADVANCED MENU SETTINGS.

## ADVANCED MENU OPTIONS CHART

	Ultra-clear mode ON/OFF Select ON to enhance the image contrast. The option is suitable for a cloudy, rainy or foggy condition
	Wi-Fi Select ON to turn Wi-Fi on
	Auto NUC ON/OFF option To refresh manually, quick press the "M" MENU (3) and "C" (CALIBRATION) (5) buttons; there will be an audible click sound made by the shutter. When operating the shutter in manual mode, it is recommended to refresh the image from time to time and especially when the image is getting noisy or non-uniformed.
	Video Output ON/OFF Select ON to transfer analog using the Type-C data cable
	Picture in picture (PIP) option Select ON to engage PIP
	Digital compass Select ON to display the digital compass on the top of the screen
	Inclinometer Select ON to engage the Inclinometer
	Battery Type 3V / 3.7V Select 3V to use with CR123 batteries. Select 3.7V to use with rechargeable CR123 batteries
	To set zeroing profiles for different rifles There are up to 4 profiles that can be preset. Press Menu button (4) to scroll between G1, G2, G3, G4.
	Hue selection Select "C" for cooler tones, select "W" for warmer tones. Option is not applicable in the color polarity mode
	Select to open Page 2 of the ADVANCED MENU SETTINGS
	Windage/Elevation adjustment sub-menu Select to make Windage and Elevation adjustments. Check the rifle profile selection prior to making adjustments. Refer below to the Adjustment orientation indicators for additional notes on W/E adjustment sub-menu
	Blind Pixel Correction Select ON to calibrate the blind pixels. Please refer to the BLIND PIXEL CALIBRATION section for additional instructions



Compass calibration option.  
Select ON to calibrate the compass. Please refer to the COMPASS CALIBRATION section for additional instructions



Stadiametric Rangefinder Setting  
Select to preset the target type, its height and the custom range distance.

There are five options for selection: a deer , a wild boar , a coyote , a hare  and a custom setting of the user choice 



Time Setting  
Select to set time



System info



Factory Reset  
To restore the factory settings, select "√" and short press the "M" button (4) to proceed with the reset. The device will reload to complete the task.  
To exit the reset sub-menu, short press the "C" button (5) or POWER button (3), select "X" then short press the "M" button (4).



Select to return to Page 1 of the ADVANCED MENU SETTINGS



Adjustment orientation indicators  
The indicators are accompanied by the directional arrows when displayed on the screen.  
To move or adjust horizontally or vertically, switch the direction by quick pressing the MENU button (4). Use POWER (3) and CALIBRATION (5) buttons to navigate in the needed direction.



Time and date icon.  
**IMPORTANT:** The time is not set in ADVANCED MENU but synced using the Wi-Fi connection. Please refer to SETTING TIME section for instructions

### BLIND PIXEL CALIBRATION

- Engage Pixel Correction menu by turning it ON on the second page of the ADVANCED MENU SETTINGS.
- A cursor will appear on the screen along with the adjustment orientation indicator. To move the cursor use POWER (3) and CALIBRATION (5) buttons. Quick press the MENU button (4) to switch between horizontal (right-left) and vertical (up-down) direction to move the cursor.
- After selecting the blind pixel, long press POWER (3) and CAMERA (5) buttons at the same time to correct the blind pixels. Long press POWER (3) and CAMERA (5) buttons again in the same position to cancel the calibrated blind pixel.
- Repeat the above steps to select and correct additional blind pixels. The number of the calibrated defective pixels is displayed at the bottom of the screen.
- To exit the BLIND PIXEL CALIBRATION, long press the MENU button (4).

**NOTE:** The procedure shall be performed with the Objective Lens Cap closed.

### COMPASS CALIBRATION

- Long press the MENU button (4) to engage the ADVANCED MENU.
- Scroll to the compass calibration option and quick press the MENU button (3). Once the ADVANCED MENU options appear on the screen, rotate the device at least 360 degrees in three axial directions in 15 seconds according to the shown direction to complete the calibration.

### RANGEFINDER MODE

- The device is equipped with the built-in Stadiametric Rangefinder that allows estimating distances to the object of the known size.
- The target type, its height and the custom range distance can be adjusted using the Stadiametric Rangefinder Setting option in the Advanced menu. Long press the MENU (4) button to open the ADVANCED MENU, scroll to the Stadiametric Rangefinder Setting on page 2 of the menu, quick press MENU (4) button to enter. Short press the POWER (3) or CALIBRATION (5) buttons to adjust the value. Quick press MENU (4) button to move to the next parameter. Long pressing the POWER (3) or CALIBRATION (5) buttons allows changing the value in a rapid mode. Long press the MENU (4) button to exit.
- To engage the Rangefinder in normal operation mode, press and hold simultaneously the POWER (3) AND MENU (4) buttons for about 3 seconds. To adjust the distance between the markers, short press (moves incrementally) or long press (moves rapidly) the POWER (3) button to widen and use "C" (CALIBRATION) button (5) to shorten.

**NOTE:** quick press simultaneously all three button to switch from yards (yd) to feet (ft).

- To display the custom range for the selected target type, press and hold simultaneously the POWER (3) AND MENU (4) buttons for about 3 seconds. The selected target type, its height and custom range value will appear on the screen as well as the two horizontal reference range lines that cannot be moved.

**NOTE:** quick press simultaneously all three button to switch the parameters values from yards (yd) to feet (ft).

When the object extends over the range lines, it means the object is in the effective range. To update or adjust the Custom Yardage, long press the MENU (4) button to enter the ADVANCED MENU. Follow the above outlined steps to adjust values.

- To exit the Stadiametric Rangefinder Mode, press and hold simultaneously the POWER (3) AND MENU (4) buttons for about 3 seconds.

### PHOTO AND VIDEO RECORDING

- Quick press the CAMERA button (5) to take a photo. The viewed image will freeze for a moment and a camera icon will pop in the upper right-hand corner of the screen momentarily.
- Long press the CAMERA button (5) to start video recording. The video recording timer will appear in the upper right-hand corner of the screen. Long press the CAMERA button to stop the recording.



**NOTE:** Quick pressing the CAMERA button (5) while the video recording is running will take a quick snap photo. The image menu options can be accessed and adjusted as needed while recording is ongoing.

- The recorded photos and videos are stored in the internal memory of the device. View and download the recorded media on a personal computer by connecting the device via a USB C-type cable. To view on the mobile device, connect Hogster using Wi-Fi to your mobile device (App required). Please refer to the WI-FI AND APP OPERATION section for additional instructions.
- The maximum duration of a video recording file is 10 minutes. When the time exceeds 10 minutes, the video will be recorded onto a new file. The number of files is limited by the capacity of the device internal memory card. It is advisable to regularly monitor the amount of free memory. Consider transferring and saving footage to other media storage devices to free up space on the internal memory card.

**NOTE** The video will not be saved if the scope was abruptly powered off and the video recording was not stopped using the CAMERA button.

**ZEROING**

- Zero your scope first at a distance of about 100yards (approx. 90 meters). Sighting in of the scope should be done at operating temperatures and Magnification set at the its native magnification of 3.0x (the setting shall be displayed at x1 on the screen).
- Select option from the ADVANCED MENU and select one of 4 rifle profile selection that can be preset in prior to making W/E adjustments. Press Menu button (4) to scroll between G1, G2, G3, G4 and to make a selection. The selection will be highlighted.
- Place the rifle on the firing station using sand bags or a special sighting rack to avoid the shooter related inaccuracy. Make sure that the scope is securely mounted on the rifle and is not lose or tilted horizontally or vertically with the respect of the viewed reticle.
- Take 3 or 4 control shots aiming at the same hit point of the target. Examine the target to determine if the aiming point coincides with the group of points of impact. If it does not, perform the W/E adjustments.
- Press and hold the MENU button (3) to engage the ADVANCED MENU. Select  W/E adjustment sub-menu option and perform necessary adjustments to align the reticle with the respect to the points of impact viewed through the scope.
- Check the accuracy of your adjustments by firing another 3 or 4 control shots. Make the adjustments based on the shot grouping.

**NOTE** In order to properly zero the thermal device, the target should be heated or have a source of heat behind it.

- To engage the freeze option of the Zeroing sub menu, press the M (4) and C (5) buttons at the same time for 3 seconds. The image "freezes" and the icon "snowflake" appears in the upper-left corner of the screen. NOTE: After the image "freezes", there is no need to keep your rifle on a target.
- To move the reticle toward the point of impact press the POWER Button (3) and CALIBRATION button (5). Quick press the M (4) button to switch between horizontal (right-left) and vertical (up-down) direction to move the reticle. There will be values of adjustment and adjustment orientation indicators displayed on the screen. When long press the POWER (3) or CALIBRATION (5) buttons, the reticle moves to the corresponding direction at 10 pixels per shift. The movement distances will be indicated by the cursor on the scales, located on the top and on the left.
- To exit the Zeroing sub-menu, long press the MENU button (4). After exiting the ADVANCED MENU SETTINGS, the image returns to normal operation.
- Check the accuracy of your adjustments by firing another 3 or 4 control shots. Make the adjustments based on the shot grouping.

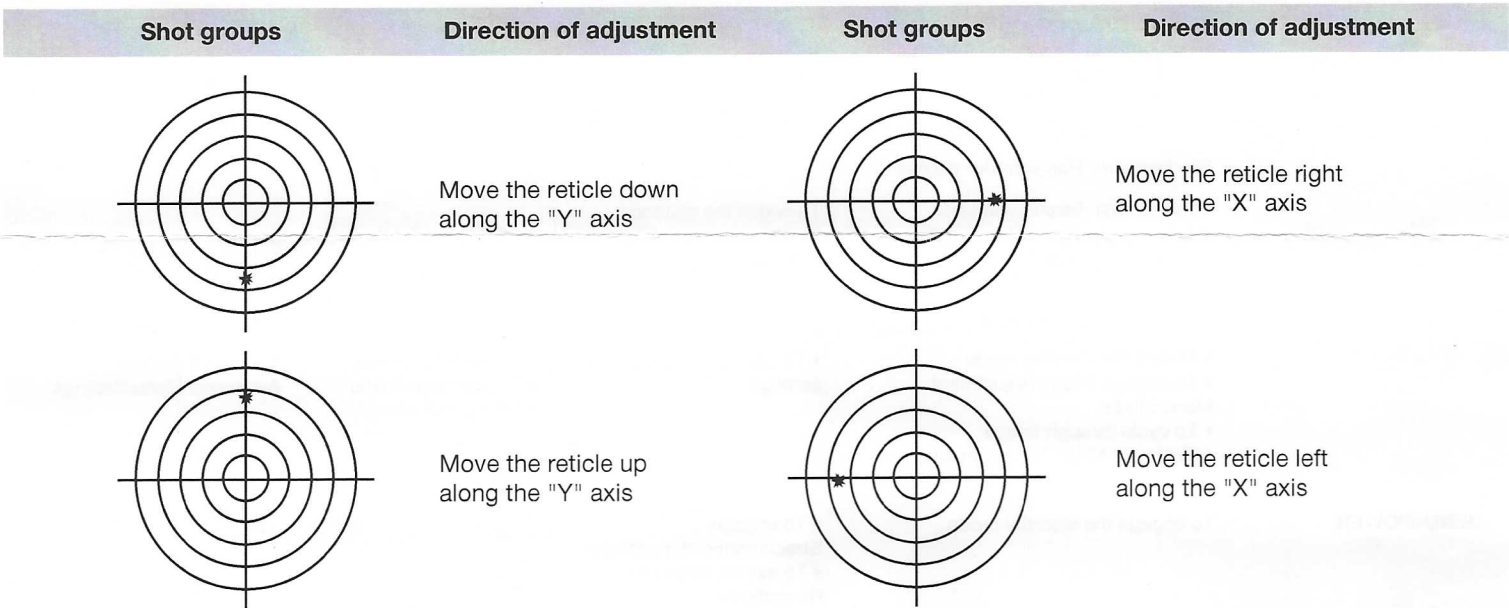

- If the point of impact cannot be seen in the scope field of view, then measure the horizontal and vertical distances between the center of the target and the point of impact. Then press the POWER (3) or CALIBRATION (5) buttons to move the reticle to the measured horizontal and vertical distances. Press the MENU (4) button to change the reticle moving direction.
- To save and exit the Zeroing sub menu, long press the MENU (4) button.

**NOTE** In the Zeroing sub-menu interface, there is a white dot that represents the original position of the reticle before the W/E adjustment.

### TO TURN RETICLE ON/OFF

To turn ON/OFF the reticle, press and hold the POWER (3) and CAMERA (5) buttons simultaneously and quick press the MENU button (4) four times to turn OFF the reticle. Press buttons in the same sequence to turn the reticle ON.

When the reticle is turned OFF, all the menu options related to the reticle will be hidden, including the setting of the reticle color and pattern (in shortcut menu), zeroing defective pixels correction in the ADVANCED SETTINGS menu.

### SETTING TIME

To set time, long press the MENU (4) button to open the ADVANCED MENU, scroll to the Time Setting option on page 2 of the menu, quick press MENU (4) button to enter. Short press the POWER (3) or CALIBRATION (5) buttons to adjust the value. Quick press MENU (4) button to move to the next parameter. Long pressing the POWER (3) or CALIBRATION (5) buttons allows changing the value in a rapid mode. Long press the MENU (4) button to exit.

**NOTE** The time is displayed in the 24-hour format.

### BUTTONS FUNCTIONALITY QUICK REFERENCE CHART

BUTTON	FUNCTIONALITY IN NORMAL OPERATION, IMAGE ADJUSTMENT MENU and GEOMETRICAL RANGEFINDER MODES		FUNCTIONS IN ADVANCED MENU MODE	
	Quick Press	Long Press	Quick Press	Long Press
<b>POWER (3)</b>	<b>Normal Operation Mode:</b>		<ul style="list-style-type: none"> <li>• To scroll upward</li> <li>• In zeroing sub-menu, to adjust Windage to the Left, pixel per click</li> <li>• To adjust Elevation Up, a pixel per click</li> </ul>	<ul style="list-style-type: none"> <li>• To adjust Windage to the Left, rapid movement</li> <li>• To adjust Elevation Up, rapid movement</li> <li>• To move rapidly in the pixel repair mode to the Left and Up</li> </ul>
	<ul style="list-style-type: none"> <li>• To adjust digital multiplication. The selection is displayed in the upper left corner of the screen.</li> <li>• To switch between "√" and "X" options in the shutdown sub- menu</li> </ul>	To open the shutdown sub-menu		
	<b>Image Adjustment Menu Mode:</b>			
	To cycle through the image menu options, located on the top of the screen			
	<b>Stadiametric Rangefinder mode:</b>			
	To widen the distance between markers, a pixel per click	To widen the distance between markers, rapid movement		
<b>MENU (4)</b>	<b>Normal Operation Mode:</b>			
	<ul style="list-style-type: none"> <li>• To exit the standby mode</li> <li>• To engage Image Adjustment Menu Mode</li> <li>• To cycle through Image Adjustment Menu Mode options.</li> </ul>	• To open Advanced Menu settings	<ul style="list-style-type: none"> <li>• To make selection</li> <li>• To open sub-menu</li> <li>• To exit sub-menu</li> </ul>	• To exit from the Advanced Menu Settings
<b>MENU+POWER</b>	To engage the standby mode	<ul style="list-style-type: none"> <li>• To engage Stradiametric Rangefinder</li> <li>• To exit Stradiametric Rangefinder</li> </ul>		
<b>MENU + CAMERA</b>	• Shutter manual correction	• Background correction to calibrate the background (Lens cover must be closed)	To freeze the image during Zeroing process in order to move reticle in to bullet hole position	

<b>CALIBRATION / PHOTO / VIDEO (5)</b>	<b>Normal Operation Mode:</b>			
	<ul style="list-style-type: none"> <li>To take a photo</li> <li>To exit standby mode</li> <li>To switch between "√" and "X" options in the shutdown sub- menu</li> </ul>	<ul style="list-style-type: none"> <li>To make video recording</li> </ul>	<ul style="list-style-type: none"> <li>To scroll downward</li> <li>In zeroing sub-menu, to adjust Windage to the Right, a pixel per click</li> <li>To adjust Elevation Down, a pixel per click</li> </ul>	<ul style="list-style-type: none"> <li>In zeroing sub-menu, to adjust Windage to the Right, rapid movement</li> <li>In zeroing sub-menu, to adjust Elevation Down, rapid movement</li> <li>To move rapidly in the pixel repair mode to the Right and Down</li> </ul>
	<b>Image Adjustment Menu Mode:</b>			
	To cycle through the image menu options, located on the bottom of the screen			
<b>Stadiametric Rangefinder mode</b>				
To shorten the distance the markers, a pixel/click		To shorten the distance between markers, rapid movement		
<b>POWER + CAMERA</b>				<ul style="list-style-type: none"> <li>To calibrate the blind pixel</li> <li>To fix calibrated pixel</li> </ul>

## CONNECTING TO WI-FI

Super YOTER R is equipped with Wi-Fi. The Wi-Fi Application enables live streaming the view through the device, take photos and record videos. Download the Bering Optics Super Hogster App from Google Play Store or Apple Store to your mobile device to use this function.

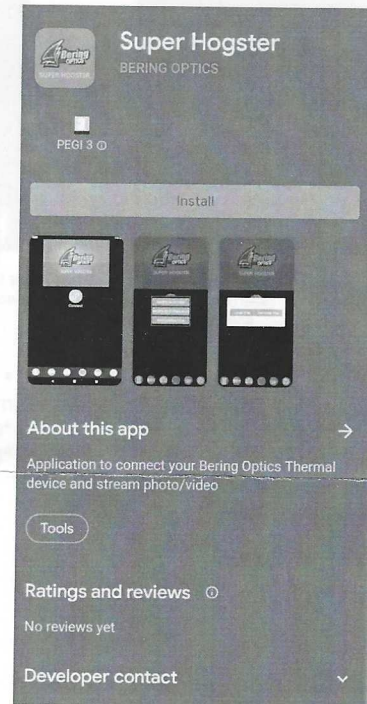
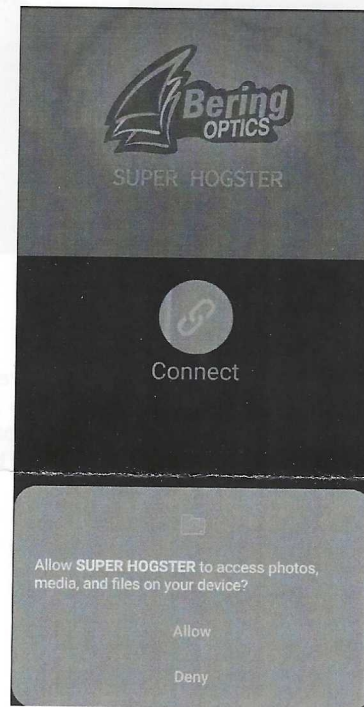
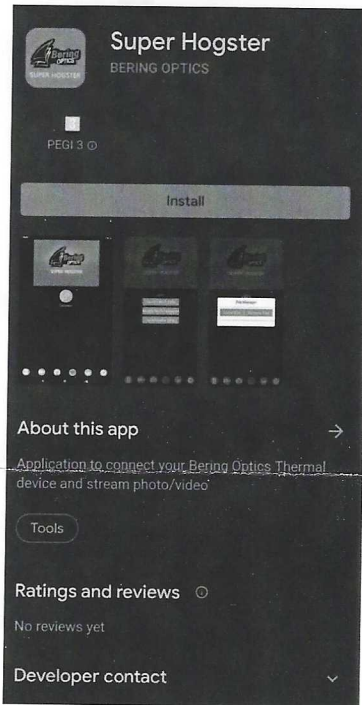

- Long press the MENU button (2) to engage the ADVANCED MENU.
  - Scroll to the Wi-Fi menu option and quick press the MENU button (3) to turn the Wi-Fi ON. SUPER HOGSTER shall now be visible to other devices equipped with Wi-Fi.
  - Open the Super Hogster App on your mobile device.
  - Press Connect button. The paired thermal device will appear in the next "Device Connect" screen. Select "HOGSTER\_XXXXX-XXXXXX" device. There will be a password required when connecting for the first time. Enter 12345678. The "HOGSTER" device shall now display as "Connected" on the Wi-Fi "Device Connect " screen of the mobile device.
- NOTE: If there is no Hogster device appears in the "Device Connect" screen, the Super Hogster is not connected to your mobile device. Repeat the above outlined steps.
- Open again the Super Hogster App; the live stream shall now be on. The consequent connections will not require a password unless the "Forget" option is selected for the given "HOGSTER" device.
  - To change the "Device Connect" password, go to Settings menu option in the Super Hogster App, which is the last icon with the wheel pictogram, and select "Modify Wi-Fi Password".

## NAVIGATING THE SUPER HOGSTER APP

- Quickly tap on the screen to view the menu options.
- To take photos, press an icon with a camera pictogram.
- To record videos, press an icon with a video camcorder pictogram. In the video recording mode, the video timer in red will appear. There is an icon with a pause sign to pause the recording.
- To view the recorded images and videos, press an icon with the folder pictogram, which is positioned second from the left in the menu option strip.
- **IMPORTANT:** The media recorded using the Hogster App will be stored in the location designated "Local File", which is the mobile device, used for the recording using the App.
- Media stored in the Hogster internal memory can be viewed and managed on the mobile device by selecting the "Remote File" location. The files will appear organized in folders.
- To view media, select the desired file location: "Local File" or "Remote File". To view a photo or play a video, simply quick press on the file icon.



Press to start/stop video recording

Press to take photos

Press to view recorded photos and videos

Settings



Press to pause the video recording

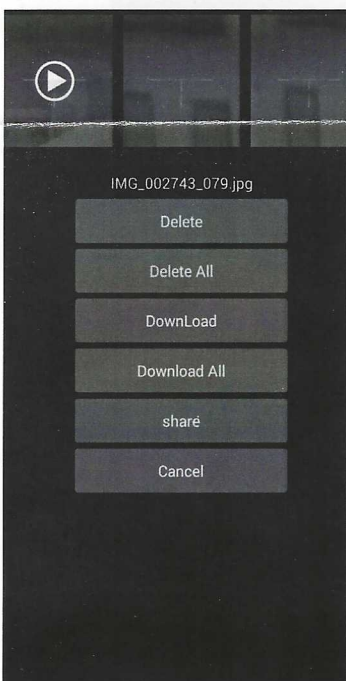

- To open the folder or file sub-menu, press and hold the media file icon. The file managing options include "Delete", "Delete All", "Download", "Download All", "share", "Cancel". For files that are already stored on the mobile device, "Local File": location, "Download" and "Download All" options will be grayed out.

## STORAGE AND MAINTENANCE

- Store and carry the device in the closed bag with the protective objective lens cap on.
- Avoid impacts, moisture and sharp changes of temperature. The optics should be protected against dust, snow, rain and direct sun rays.
- Store the device in dry conditioned premises without battery away from sources of heat, such as heating appliances or central heating.
- Do not store the device at temperatures lower than 10°C (50°F) or higher than 60°C (140°F).
- Remove batteries during extended periods of non-operation to avoid battery leakage.
- Clean optical surfaces with clean lens cloth.
- Wipe the device housing with lightly dampened clean lint-free cloth.

## PREVENTIVE MAINTENANCE CHECKS

**OPTICS:** Always clean the optics with a suitable optical cleaning cloth. Do not use detergents or excessive moisture to clean any part of the Device.

**BATTERY / BATTERY COMPARTMENT:** Remove the batteries when storing the device for a long period of time.

**MOISTURE:** The device is waterproof, however; no warranties or guarantees apply to a device that has been submerged in water.

**SALT WATER:** If the unit is exposed to salt water, wipe it off with a clean damp cloth and dry thoroughly.

**CAUTION:** The device is a precision electro-optical instrument and must be handled carefully. Do not scratch the external lens surfaces or touch them with your fingers.

#	Interval	Location (Item to Check/Service)	Procedure	Not Fully Mission Capable if:
1.	Before/After	Optical Surfaces	Inspect lens for dirt, fingerprint residue, chips, or cracks. If necessary, clean and dry lens with water and lens tissue.	Scratches or chips hinder the vision when the device turned on, or if cracks are present.
2.	Before/After	External Surfaces	Inspect for cracks or damage. Scratches and gouges are OK if operation is not affected.	Cracked or damaged.
3.	Before/After	Battery Cap, Compartment	Check to make sure battery cap is present and in working condition. Remove battery and inspect for corrosion, moisture or cracks. Ensure o-ring is present and is not dry or cracked. Battery Cap retainer is present and clear of damage.	Cap is missing, corroded or damaged. O-ring is missing or cracked. Battery Cap retainer is missing or damaged.
4.	Before/After	Operating Buttons	Ensure the button functionality.	One or more buttons are non-operational. The button is missing or broken.
5.	Before/After	Viewed Image	Inspect display for operational defects.	Flashing or shading is observed.

## TROUBLESHOOTING PROCEDURES

MULFUNCTION	TEST OR INSPECTION	CORRECTIVE ACTION
Device fails to activate	<ul style="list-style-type: none"> <li>a) Not holding the POWER ON button for sufficient time to start up the device.</li> <li>b) Dead or weak batteries.</li> <li>c) Check for defective, missing or improperly installed batteries.</li> <li>d) Battery cap is loose, no contact.</li> </ul>	<ul style="list-style-type: none"> <li>a) Press and hold POWER ON button for at least 5 seconds.</li> <li>b) Replace batteries.</li> <li>c) Reinstall batteries.</li> <li>d) Check the battery compartment lid.</li> </ul>
No visible image	<ul style="list-style-type: none"> <li>a) Objective lens cap has not been removed.</li> <li>b) Weak batteries.</li> </ul>	<ul style="list-style-type: none"> <li>a) Remove cap.</li> <li>b) Replace batteries.</li> </ul>
Device shuts down after being "ON"	<ul style="list-style-type: none"> <li>a) Inspect the battery compartment lid</li> <li>b) Weak batteries.</li> </ul>	<ul style="list-style-type: none"> <li>a). Refer to the BATTERY INSTALLATION instructions and close the lid properly. There shall be no gaps, no O-ring visible; it shall be fully sealed. If the battery compartment lid malfunctions: latches jammed, not moving (no clicks when close), rubber O-ring is missing, contact Bering Optics for service</li> <li>b). Replace batteries.</li> </ul>
Device froze off- does not react to any control buttons or power "ON/OFF" switch		<ul style="list-style-type: none"> <li>a) Remove batteries from the battery compartment. Reinstall batteries to resume operation.</li> <li>b) Contact Bering Optics for service.</li> </ul>

Image dimmer than usual	a) Weak batteries.	a) Replace the batteries.
Blurry image	a) Check focus. b) No image correction for a long time.	a) Adjust focus adjustment knob. b) Manually calibrate the shutter. c) Manually calibrate the image background.
Poor image quality	a) Check focus. b) Check for fogging or dirt on lenses. c) No image correction for a long time.	a) Refocus. b) If image quality is still poor, contact Bering Optics for service.
Dark Screen	a) Check screen BRIGHTNESS settings.	a) Adjust the screen Brightness if needed.
Battery compartment is difficult to open.	a) Visually inspect for the presence of an o-ring. b) Check for a damaged battery cap.	a) If O-ring is missing, contact manufacturer for assistance. b) If damaged, return to manufacturer.
Device does not shut OFF		a) Remove batteries from the battery compartment. Reinstall batteries to resume operation. b) Return device to manufacturer if the situation persist.
No analog video output	a) No video out. b) Damaged cable.	a) Make sure the analog video out option is turned "ON" in the ADVANCED MENU SETTINGS. b) Replace data cable.

### BERING OPTICS WARRANTY POLICY

Your Bering Optics product is warranted free of defects in workmanship and materials. In the event of a defect under this warranty, we will, repair the product. For night vision products, the image intensifier tube that enables night vision capability is warranted to be free from defects for a period of 2 years for Gen 1 and Photonis, 3 years for Gen 3 and Gen 3+, as are other light emitting devices such as IR Illuminators, red dots, and telescopic sight. Thermal imaging systems are warranted for 3 years with exception of the Hogster, Super Hogster and Super Yoter line products that are warranted for 4 years. Light bulbs and batteries are not applicable to this warranty. This warranty does not cover damages caused by misuse or improper handling. Also, this warranty is null and void if modification or maintenance is provided by a third party not authorized by Bering Optics.

Any product returned under this warranty or for repair must be accompanied by the following items:

- Return Authorization Number (RA#) — to obtain RA#, email to [optics@beringoptics.com](mailto:optics@beringoptics.com). Write RA# on the top of the shipping box.
- A brief letter explaining the problem
- Defective product
- Copy of the original receipt showing when and where the product was purchased
- Contact person's name, address and a daytime phone number.

The product shall be sent in the sturdy package to prevent damage in transit with postage prepaid per the shipping instructions received with the Return Authorization Number (RA#).

### STATEMENT OF LIABILITY

Bering Optics will not be liable for any claims, actions, suits, proceeding, costs, expenses, damages or liabilities arising from the use of this product. Operation and use of the product are the sole responsibility of the user. The provision of products sold and services performed by manufacturer to the user shall not be interpreted, construed, or regarded, either expressly or implied, as being for the benefit of creating any obligation toward any third party of legal entity outside manufacturer and the user. The remedies of the purchaser set forth herein are exclusive and the total liability of manufacturer shall not exceed the purchase price of the unit. The user is solely responsible to comply with local and national laws regarding use of this product. In no event shall manufacturer be liable for consequential, incidental, special or other damages.

Bering Optics reserves the right to make alterations or modifications in its products at any time, which in its opinion may improve the performance and efficiency of the product. It shall not be obligated to make such alterations or modifications to products already in service.

### EXPORT DISCLAIMER

Export of some the Bering Optics products is strictly prohibited without a valid export license issued by the U.S. Department of State, in accordance with International Traffic in Arms Regulations (ITAR) (22 C.F.R. 120-130) or a valid export license issued by the U.S. Department of Commerce, in accordance with the Export Administration Regulations (EAR) (15 C.F.R. 730-774). U.S. law prohibits the sale, transfer, or export of items to certain restricted parties, destinations, and embargoed countries, as identified on lists maintained by the U.S. Department of State, the U.S. Department of Commerce, and the U.S. Department of Treasury.

It is unlawful and strictly prohibited to export, or attempt to export or otherwise transfer or sell any hardware or technical data or furnish any service to any foreign person, whether abroad or in the United States, for which a license or written approval of the U.S. Government is required, without first obtaining the required license or written approval from the Department of the U.S. Government, having jurisdiction. Diversion contrary to U.S. law is prohibited. It is the responsibility of the Customer to be aware of these lists, which can be found at the U.S. Government websites. By proceeding with any transaction, the Customer certifies that the Customer will not engage in any unauthorized transaction involving the export of the Bering Optics products to any restricted parties or destinations.

BERING OPTICS  
101 Decker Drive, Suite #120, Irving, TX 75062  
Ph. 817-453-9966  
[www.beringoptics.com](http://www.beringoptics.com)

