

X20

USER MANUAL

Package Content

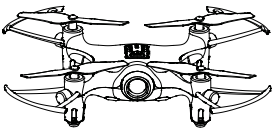

1x Drone

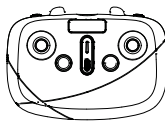

1x Remote Control

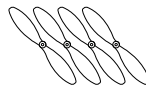

4x Blade Replacement



1x Screw Driver



1x USB Charging Cable

DISCLAIMER

Read this disclaimer and instructions thoroughly before operating this device. THE USE OF THIS PRODUCT IS A SIGN OF YOUR COMPLIANCE WITH THIS DISCLAIMER. You are responsible for your own actions, behavior, and conduct while using this device. You agree to use this product in such a way that you will comply with all local and federal regulations, including, but not limited to, personal privacy laws. Syma and Tenergy Corporation will not be held liable for any damages or legal responsibilities resulting from the use of this product. This product is NOT suitable for anyone under the age of 8.

Safety guidelines for sUAS recreational users

- Follow community-based safety guidelines, as developed by organizations such as the Academy of Model Aeronautics (AMA).
- Fly no higher than 400 feet and remain below any surrounding obstacles when possible.
- Keep your sUAS in eyesight at all times, and use an observer to assist if needed.
- Remain well clear of and do not interfere with manned aircraft operations, and you must see and avoid other aircraft and obstacles at all times.
- Do not intentionally fly over unprotected persons or moving vehicles, and remain at least 25 feet away from individuals and vulnerable property.
- Contact the airport and control tower before flying within five miles of an airport or heliport.
- Do not fly in adverse weather conditions such as in high winds or reduced visibility.
- Do not fly under the influence of alcohol or drugs.
- Ensure the operating environment is safe and that the operator is competent and proficient in the operation of the sUAS.
- Do not fly near or over sensitive infrastructure or property such as power stations, water treatment facilities, correctional facilities, heavily traveled roadways, government facilities, etc.
- Check and follow all local laws and ordinances before flying over private property.
- Do not conduct surveillance or photograph persons in areas where there is an expectation of privacy without the individual's permission (see AMA's privacy policy).
- Before each flight, check and ensure the drone and controller are not damaged, and that all components are working in accordance with the user instruction .
- If you want to use unmanned aircraft systems for a commercial purpose: you can apply for an exemption from the FAA to operate commercially. For more information about how to apply for an exemption, visit the FAA's "Section 333".

FLY RESPONSIBLY

The Federal Aviation Administration requires registration of many drones flown in the US, for hobby or commercial purposes. To learn more about drone registration requirements, visit "Know Before You Fly" at:

www.knowbeforeyoufly.org

ADULT SUPERVISION REQUIRED

An adult should check the unit and LiPo battery for damages prior to each use. Drones have rotating blades that move at high speeds, posing a danger of damage and injury. Pilots are responsible for any action that results in damages or injury from improper operation of the drone. Adequate flying space is required. Avoid flying near interior fans and/or vents as they may affect your ability to control the drone. Keep a safe distance from streets, public thoroughfares, and power lines. Never attempt to retrieve the drone from any location higher than your reach (rooftops, trees, etc) or any location that poses a safety hazard. Never fly the drone at night. Keep drone in sight at all times during operation. Discontinue operation immediately if the drone flies out of your field of view. Do not fly near spectators. Keep away from pets, as they may become excited over R/C vehicles. Keep spinning rotors away from fingers, hair, eyes, and other body parts. Always launch from a flat surface. Never leave Drone unattended while it is turned on. Read all enclosed information before operating.

LITHIUM BATTERY CAUTIONS

LiPo batteries pose a serious hazard when used improperly and may result in overheating, fire, or explosions. Read all precautions and instructions regarding the care and use of LiPo batteries prior to use. The enclosed LiPo battery is to be used only with the vehicle and charger included in this package.

- Keep away from flammable materials
- Do not expose to direct sunlight
- Do not expose to extreme heat
- Do not drop or make subject to strong impact
- Keep dry and away from moisture
- Remove exhausted batteries as soon as possible and discard properly
- Remove all batteries when toy is inactive for long periods
- The supply terminals are not to be short circuited

LiPo Battery Disposal: LiPo batteries must be recycled and disposed of properly. LiPo batteries should not be disposed of with household waste. **Check your local laws and regulations for information on proper battery disposal.**

WARNING: Batteries are harmful if swallowed. Please keep away from children.



The crossed-out dust bin symbol indicates that batteries (primary, rechargeable, button cells, packs, etc) must not be put in household waste. These items may be composed of hazardous materials. Please help protect the environment from health risks by disposing of the batteries properly, and taking them to a local collecting facility for safe recycling.



Waste Electrical and Electronic Equipment (WEEE)
When this appliance is out of use, please remove all batteries and dispose of them separately. Bring electrical appliances to the local collecting points for waste electrical and electronic equipment. Other components can be disposed of in domestic refuse.



This product is in compliance with the essential requirements and other relevant provisions of Directive 1999/5/EC.

FCC Statements

This device complies with Part 15 of the FCC Rules. Operation is subject to the following two conditions:

1. This device may not cause harmful interference.
2. This device must accept any interference received, including interference that may cause undesired operation.

Note: This equipment has been tested and found to comply with the limits for a Class B digital device, pursuant to Part 15 of the FCC Rules. These limits are designed to provide reasonable protection against harmful interference in a residential installation. This equipment generates, uses and can radiate radio frequency energy and, if not installed and used in accordance with the instructions, may cause harmful interference to radio communications. However, there is no guarantee that interference will not occur in a particular installation. If this equipment does cause harmful interference to radio or television reception, which can be determined by turning the equipment off and on, the user is encouraged to try to correct the interference by one or more of the following measures:

- Reorient or relocate the receiving antenna.
- Increase the separation between the equipment and receiver.
- Connect the equipment into an outlet on a circuit different from that to which the receiver is connected.
- Consult the dealer or an experienced radio/television technician for help.

Caution

1. Always use dry and soft cloth to clean this product.
2. Avoid this product to be exposed to sunlight or heat.
3. Avoid immersing these toys into water, otherwise ,the electronic parts may be damaged.
4. Regularly check and inspect the plug and other accessories. If any damages are discovered, please immediately stop using it, until it is completely repaired in good working condition.

Part Description

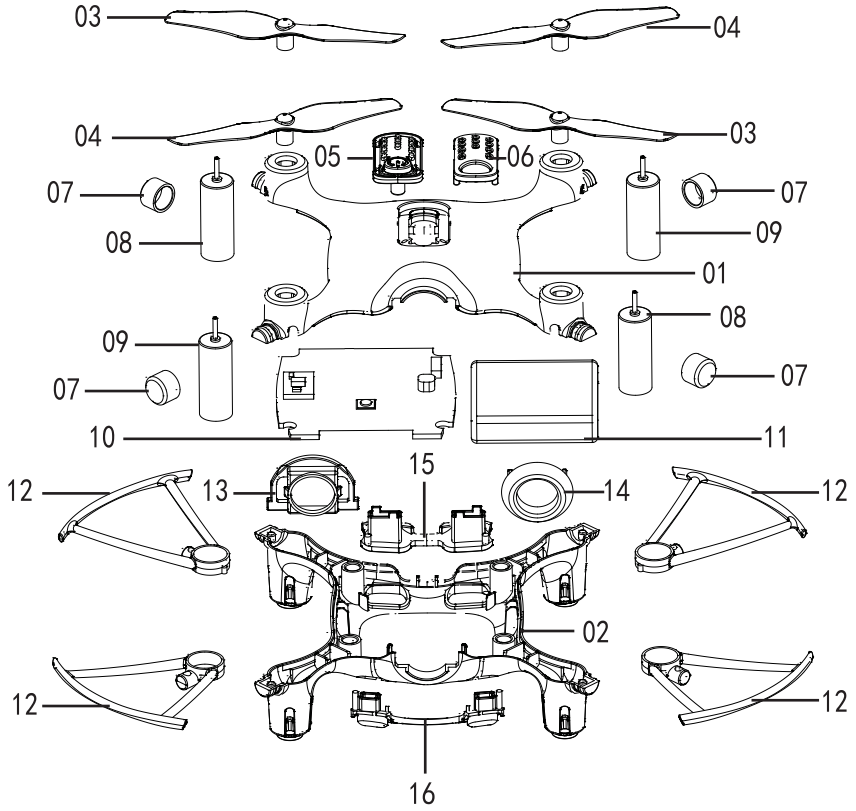

	Product Name		Product Name	
01	Top Main Body	09	Motor(Counter-clockwise Direction)	
02	Bottom Main Body	10	Circuit board	
03	Blade(Clockwise Direction)	11	Battery	
04	Blade(Counter Clockwise Direction)	12	Protective Gear	
05	Plating Object	13	Ornament Connecting Parts	
06	Ornament Part	14	Camera Cover	
07	Body Connecting Parts	15	Back Lamp Cover	
08	Motor(Clockwise Direction)	16	Front Lamp Cover	

Remote Control

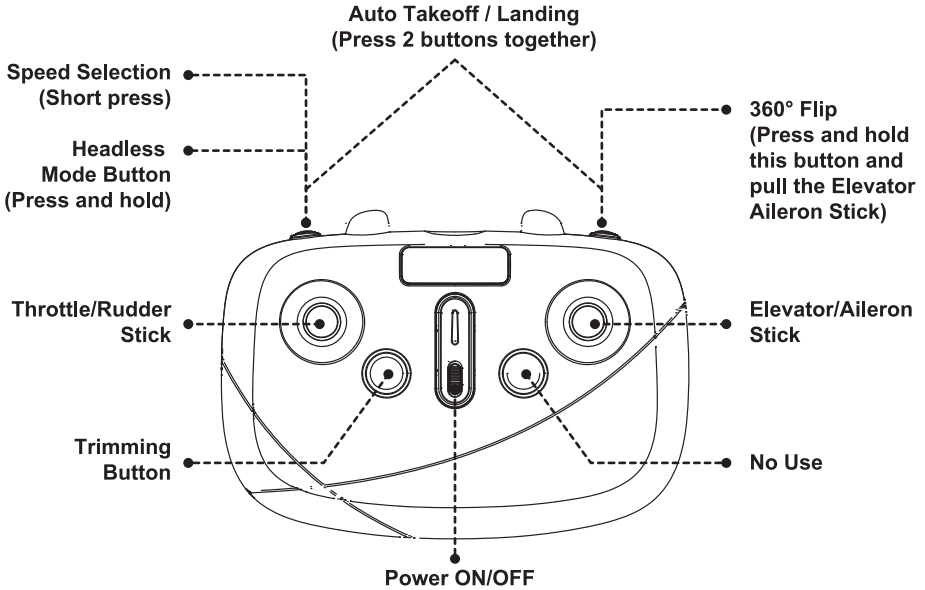

Install battery for controller

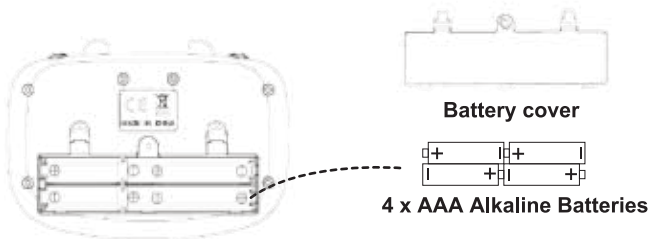

1. During the battery installation, it must be ensured that the polarities of the batteries are matched with that of the battery box. No battery should be installed with the opposite polarity.
2. Please do not use new and old batteries together.
3. Please do not use different types of batteries together. Use 1.5V alkaline AAA batteries only.

Flight Preparation

Charging the drone

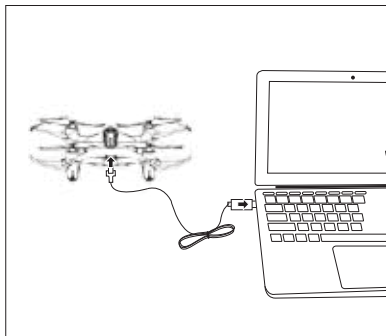

1. Connect the drone to a powered USB port (such as the ones from a computer) using the provided USB charging cable

2. The LED indicator light will be on while charging and off when charging is completed.

3. Unplug the cable after charging is completed.

**Charging time may take up to 70 minutes.
Flight time will be approx. 5 minutes per charge.**

Binding drone to the controller



1. Place the drone on a level and flat surface.

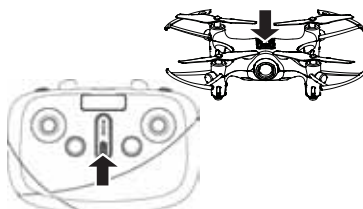

2. Turn on the controller and the Drone.

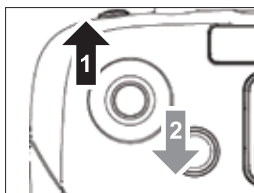

3. Pull the left stick Up and then Down



4. The LED on the drone will stop flashing when binding is completed.

Start / Stop The Motors

To start the motors upon successful binding:

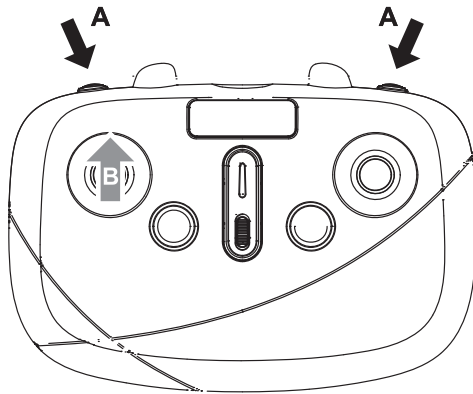

You can:

A: Press both buttons on the top simultaneously to start the motors.
or

B: Pull the left stick up to start the motors.

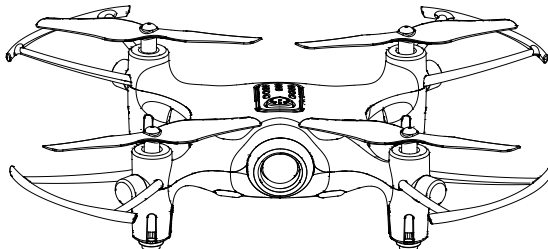

To land and stop the motors:

You can press both buttons on the top again, or pull and hold the left stick down to land the drone.

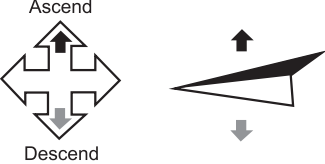
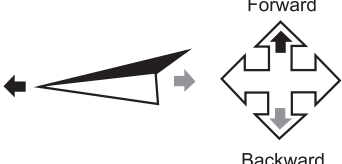
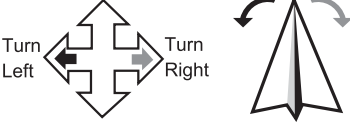
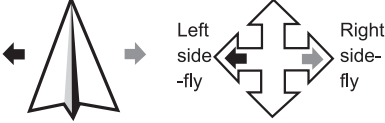

Basic Control

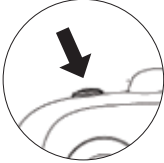
Left Stick	Right Stick
	
	

Enter Headless Mode *	Flying Speed Select
 <p data-bbox="293 778 494 879">Long press the left top button (hold for 4 seconds) to enter Headless Mode</p>	 <p data-bbox="735 778 944 852">Short press the left top button to switch flying speed</p> <p data-bbox="735 879 902 930">1 beep = normal 2 beeps = fast</p>

* To enter headless mode:

- 1) Before taking off, position the drone in such a way that "its front is your front".
- 2) Press down and hold the left top button for 4 seconds to enter headless mode.
- 3) Press down and hold the left top button for 4 second again to get out of headless mode.

Note:

- The controller will keep on beeping continuously for a while when the drone is in headless mode.

Special Operation / Control

360° Flip

1. Bring the drone to a 10ft mid-air hover, without flying towards any direction. Remove finger from both sticks once in hover.
2. While hovering, press and hold the 360° Flip button and pull the right stick to any direction.
3. The drone will flip to the direction of right stick being pull.

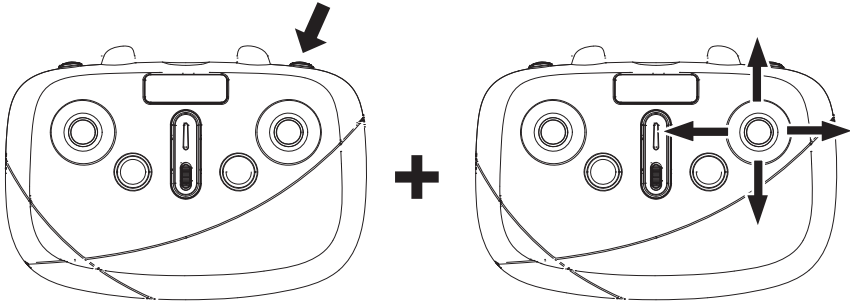
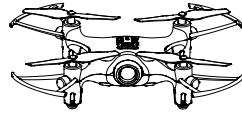

Forward flip

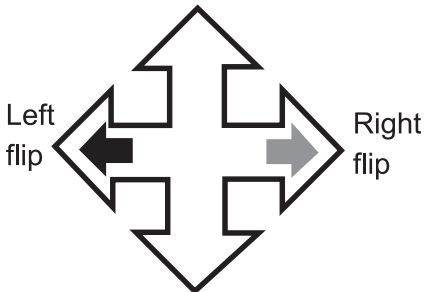

Left flip

Right flip

Backward flip

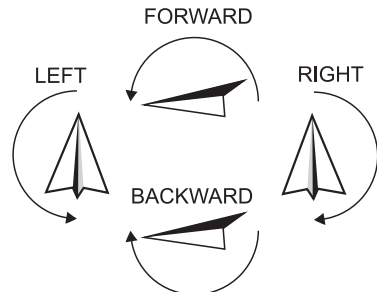

Note:
The 360° Flip function cannot be performed when battery power is low.

Drone needs to be hovering at least 10ft in height before flipping. Do not use this feature indoor to avoid damage.

Adjustment / Trimming

Why do we need to adjust the trimming

In the perfect scenario, the drone should be able to stay completely level in the air and hold its same position above the ground; but in the real world this perfect scenario doesn't just happen all the time and some manual adjustments may be needed.

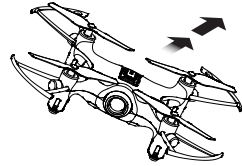

Recalibrate

It is a good idea to recalibrate the gyro system of your drone before manually trimming it. A lot of drifting can be fixed by simply recalibrate the drone:

- 1) Bind the drone to the controller, place the drone on a flat and level surface.
- 2) Push both left and right stick (on the controller) to bottom right corner, hold it for 3 seconds or until the LED on the drone stop flashing.
- 3) Recalibrate is complete upon LED on drone stop flashing.

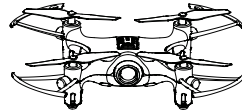
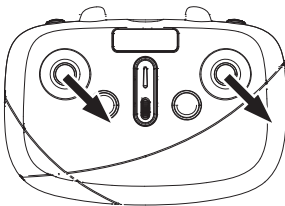

Manually Trimming the drone

If unwanted drifting still presents after recalibrate, a manual trimming may be needed.

To do so:

- 1) Press down and hold the trimming button.
- 2) While pressing the trimming button down, push the right (or left) stick to the opposite direction of the drifting. (See next page for examples)
- 3) Let go of the trimming button to finish trimming.

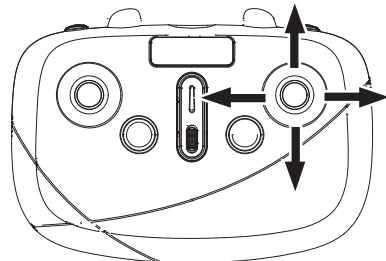
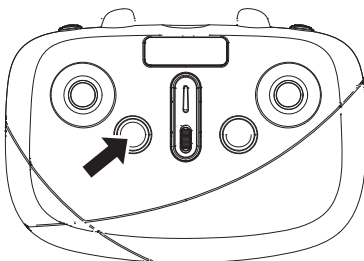

Adjustment / Trimming

Forward / backward trimming

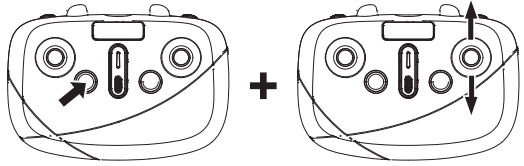
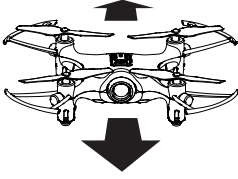

Left/right side trimming

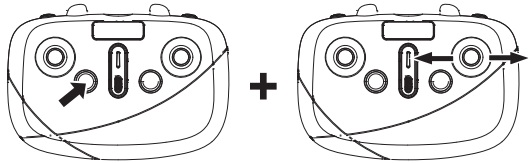
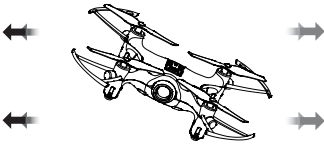

Left/right turning trimming

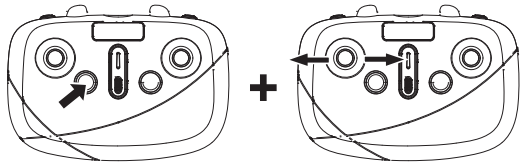

Erase Trimming settings

Manually trimmed settings can be cleared by doing the following:

- 1) Power OFF the controller.
- 2) Press down and hold the left stick.
- 3) Power ON the controller.
- 4) Let go of the left stick.

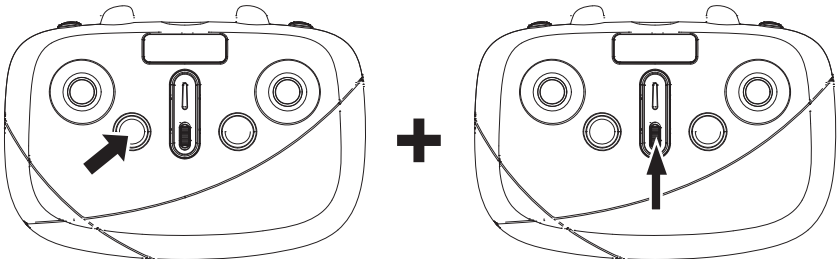

Blade Installation

Blades must be installed as shown below.

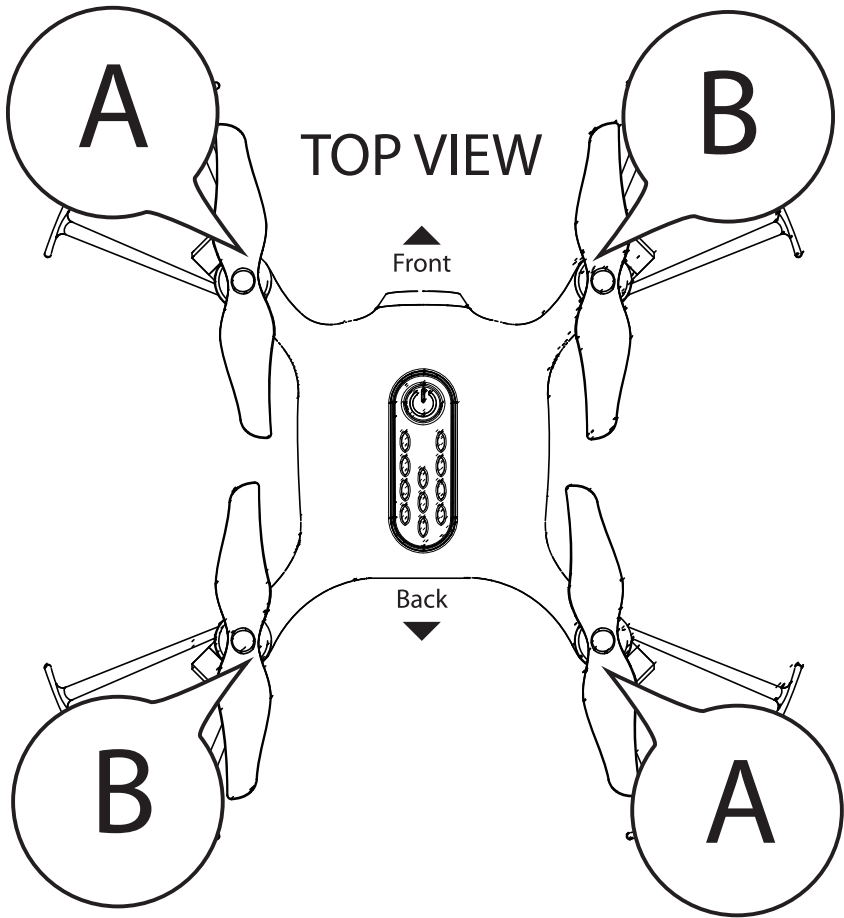

The letters are printed on reverse side of blades.

Note:

Over time, debris such as loose hair or carpet fibers may get wound in the blades and motors. The debris should be regularly removed and cleaned to prevent buildup, and to avoid poor flying performance.

Flying Tips

When launching the drone, face the same direction as the drone. The yellow blades should be in front.

Practice launching, hovering, and landing before attempt to learn other moves.

Flying 2 to 3 feet above the ground will reduce ground turbulence and make flying easier.

When first attempting to fly in a different direction, start by tapping the Direction Stick until you get the hang of it. Always move controls slowly until you become comfortable operating the drone.

Once you've mastered flying in different directions, practice rotational controls. Keeping the drone facing the same direction as you makes flying easier and more intuitive.

Stay away from walls and ceilings, as the drone will be drawn towards them if you fly too close.

If the propeller blades come in contact with another object, or you crash, throttle down immediately to prevent further damage.

If anything prevents the drone's blades from spinning, or they become jammed, **THROTTLE DOWN IMMEDIATELY**. Do not attempt to fly until obstruction has been removed and damage fixed.

Troubleshooting

Problem/Issue	Cause	Solution
Cannot bind drone to controller	a) Battery b) Electromagnetic interference c) Out of range	a) Make sure the batteries in both drone and controller are fully charged b) Clear out objects between drone and controller c) Put drone and controller closer to each other
Drone does not turn on	a) Battery too low b) Battery not fully plugged in	a) Charge battery b) Battery fully plugged in the correct direction
Controller does not turn on	a) Switch didn't turn on b) Battery didn't install correctly c) Battery power too low	a) Ensure switch is turned on b) Ensure battery fully plugged in correctly and securely C) Charge the battery
Blades do not spin or drone has difficulty taking off the ground, LEDs are flashing	Battery power level is too low Blades are not installed correctly	Fully recharge the battery Reinstall the blades following the "Blade Installation" section
Unstable drone flying / drifting sideways	Damaged blade(s) Gyro off-balance	Replace the blade(s) Recalibrate and trim the drone as necessary
All blades spin but drone does not take off the ground or not flying properly	Blades are not installed correctly	Reinstall the blades following the "Blade Installation" section
Drone crashes immediately	Blades are not installed correctly	Reinstall the blades following the "Blade Installation" section on page 7
Drone crashes during 360° Flip	Not enough space to perform the rolling function	Ensure the drone is at least 9ft from ground and 9ft away from all other objects in all direction
Drone can not perform 360° Flip and LEDs are flashing	Battery power level is too low	Fully recharge the battery

Thank You
Happy Flying

