

## I.Precaution

To avoid fire or electrical shock, do not expose this product to rain or moisture.

To avoid short circuit, please sure the batteries contacts are securely packed and in accordance with local provisions when handling the battery.

Please place the batteries and the parts which can be swallowed mistakenly away from children. Contact a doctor immediately when it occurs.

To avoid possible injury to eyes, do not use the flash light in a short distance from the eyes.

To avoid possible safety accident, do not use the flash light on the people who need a high degree of attention.

Please take out the batteries and stop using immediately in case of below.

- This product is dropped or shocked seriously and the inner part of the product is bared.
- If the battery leaks corrosive liquids, please take out the battery with gloves.
- The product gives off strange smell, heats or smokes.

Do not disassemble or maintain this product. Touching the internal high voltage circuit will cause electric shock.

Please take out all the batteries if not use this product for a long time.

## II.Features

### ● **COMPATIBLE WITH P's WIRELESS FLASHING SYSTEM**

One YN585EX can receive the wireless signal from AF-360FGZ、AF540FGZ II and built-in flash of Pentax master units,supports 4 channels,achieves off-camera TTL and manual flash.

### ● **COMPREHENSIVELY SUPPORTS TTL FUNCTIONS**

Supports Exposure Compensation, Bracket Exposure, Rear-curtain sync, red-eye reduction.

### ● **TTL FLASH WITH HIGH GUIDE NUMBER**

GN58@ ISO100, 105mm; supports TTL、M、MULTI flash mode.

### ● **MULTIPLE TRIGGER MODE SUPPORTED**

YN585EX can be triggered by the camera set-top, built-in or master wireless flash,S1 and S2 pre flash cancel mode.

### ● **Supports USB Firmware Upgrade**

The YN600EX-RT equipped with the USB interface,you can download the upgrade firmware through the Yongnuo official website to upgrade the flash.

### ● **SUPPORT AUTOMATIC/MANUAL ZOOMING**

Supports auto and manual zooming, the zoom range can be adjusted between 20~105mm.

### ● **FAST CURRENT-RETURN SYSTEM**

The recycle time is just around 3 seconds at full output, 4~5 seconds ultra-fast time to recycle even if

not using the new batteries.

- **Real-time Battery Power Display**

Supports real-time display the battery power, which convenient you to know the battery status timely.

- **Equipped with the AF-assist Beam Emitter**

The YN585EX is equipped with the AF-assist beam emitter,allows you to focus easily in dark environment.

- **SOUND PROMPT SYSTEM**

When the sound prompt system is enabled, different sound modes will prompt different working conditions of the speedlite so as to allow you to focus on shooting process.

- **SUPPORTS ADVANCED OPTION SETTINGS and AUTOMATIC SETTINGS SAVING**

- **Equipped with LCD PANEL and 2.5mm PC synchronous interface**

### III. Quick Start

**If you don't have much time to read the whole user manual, we advise you to read this section.**

1. Please avoid the excessive use of the output with maximum power. It can effectively extend the service life of this product. (It is recommended that the speedlite should be idle for more than 10 minutes when entering the overheating protection.)

2. You can operate each buttons and observe the changes of the displayed content to understand their respective functions.

4. Short press the **【MODE】** button to choose switch the P-TTL/M/Multi; long press the **【MODE】** button to enter the trigger mode setting state, then short press the [LEFT] or [RIGHT] button to select trigger mode: Set-top/Off-camera flash (SLAVE), Off-camera flash including SP/S1/S2.

4. Set-top P-TTL mode, short press the **【SYNC/CH】** button to switch front-curtain and rear-curtain; Off-camera SP status, long press the **【SYNC/CH】** button to enter wireless channel setting state.

5. Short press the **【ZOOM/FN】** button to enter focal length setting state; long press the **【ZOOM/FN】** button to enter Advanced Options Setting state.

6. Press the [UP], [DOWN], [LEFT] and [RIGHT] buttons can quickly adjust the parameters of speedlite at the current mode. For some parameters, the central [OK] button is need to press several times for setting.

7. Operating the **【MODE】** + **【SYNC/CH】** buttons can restore the trigger mode, flash mode, output power and focal length to factory default settings; the Advanced Options Setting will not cleared.

## IV.COMPONENTS DESCRIPTION (Please familiar with this part carefully, allowing you to quickly familiarize with the product features)

- 1.Wide reflection board
- 2.Wide panel
- 3.PC input port
- 4.USB port
- 5.Terminal cover
- 6.Battery compartment cover
- 7.Wireless trigger sensor
- 8.Remote indicator
- 9.AF-assist beam emitter
- 10.Lock-release button
- 11.Sound hole
- 12.Hot shoe stand
- 13.Hot shoe contact

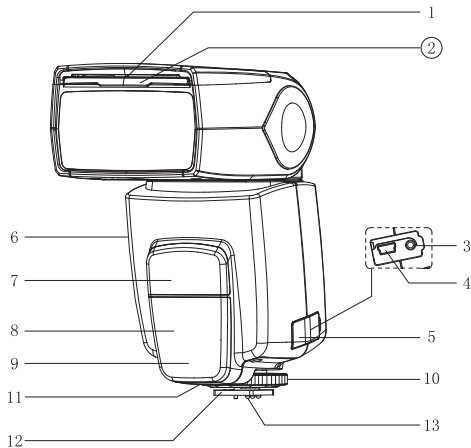

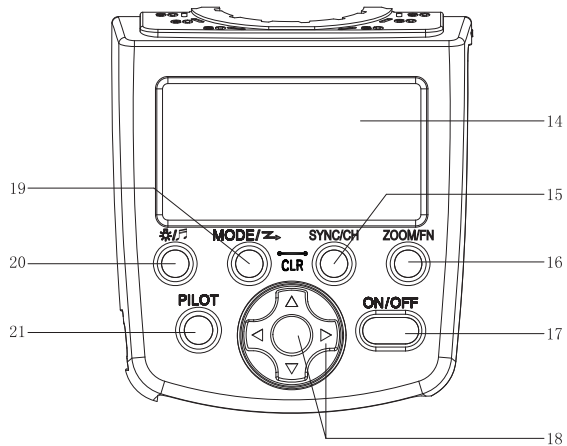

**14. LCD screen:** Displays all functions and application setting of the speedlite, convenient for view and quick setting.

**15.Synchronized mode/Channel button (SYNC/CH):** normal P-TTL mode,short press the button to set the front curtain sync or rear curtain sync function;Off-camera SP mode,long press the button to enter the channel setting state.

**16. Zoom/Advanced options setting button (ZOOM/FN):** Short press the button to enter focal length setting status;long press the button to enter advanced options setting state.

**17. Power switch (ON/OFF):** Press this button for about 2 seconds to turn on or off the power of speedlite.

**18.Selection/setting button set:** Including the [Left], [Right], [Up], [Down] and central [Ok] button; Through the buttons can set exposure compensation,output power,intensity tuning,stroboscopic flash times,stroboscopic flash frequency,advanced options,advanced options parameters and the relevant options of the wireless flash.

**19.Mode/Trigger mode switch button(MODE):** Short press the button can switch the flash mode, long press the button to enter trigger mode select status.

**20.Backlight/Sound prompt button:** Short press the button can turn on/off the LCD panel backlight; press the button for around 2 seconds will turn on/off the Sound prompt function.

**21.Charge indicator/Test button (PILOT):** Red light indicates charging is completed and flash can work; blue light indicates charging is being on, and press this button, the speedlite will emit test flash.

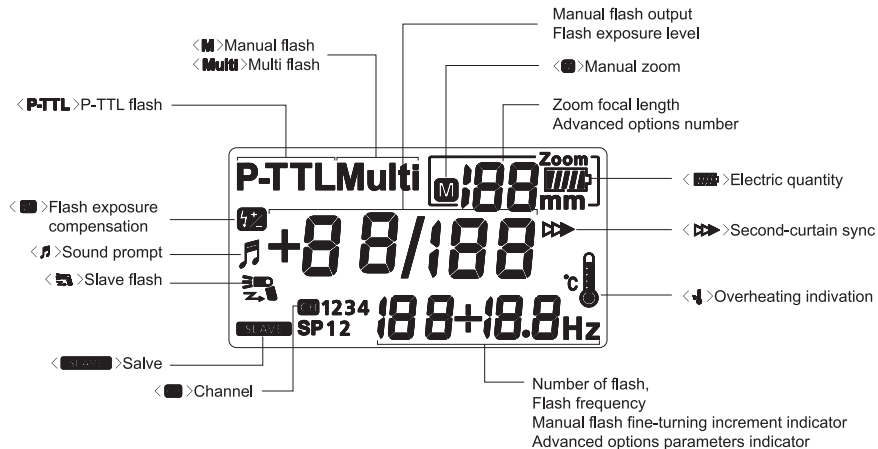



## V. Installation Instruction

### 1. Install Batteries

Slide the [battery compartment cover] in the direction of the arrow as shown.

Insert the batteries according to the label inside battery chamber and make sure the direction of the battery contact (+/-) is correct.

Close the [battery compartment cover] in the direction of the arrow as shown.

**Note:** Please use four standard specification AA batteries. To avoid circuit, please do not use damaged batteries.

### 2. Install on the Camera

Loosen the locking ring by rotating it in the direction of the arrow.

Slip the speedlite hot shoe stand into the camera hot shoe stand until it stops

Tighten the locking ring in the direction of the arrow.

To detach the speedlite, loosen the locking ring, then push it from the camera hot shoe.

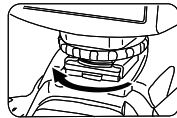
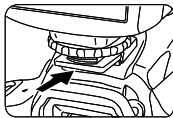
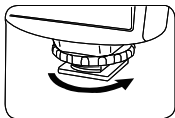
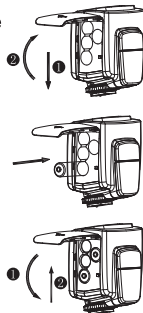

## VI. Basic Functions

### 1. Basic operations

#### Button Operation:

Parts	Operation
[ON/OFF] Button	Turn on or off the power of speedlite by long pressing this switch. It is recommended to take out the batteries after turning off the power of the speedlite.
[MODE] Button	When used on set-top camera, the flash mode will switch between TTL/M/Multi by each press. When the speedlite used as SP slave unit, the flash mode will switch between P-TTL/M by each pressing. Long press the button will enter trigger mode setting state.
[Backlight/Sound] Button	LCD backlight can be turned off by short pressing this button; And the sound prompt function will be turned on or off by long pressing this button for about 2 seconds.
[SYNC/CH] Button	When using the set-top P-TTL mode, the speedlite will switch between rear curtain sync/front curtain sync with each press; when used as slave unit, long press the button to select the channel, then set the channel (1/2/3/4) through the [Left] and [Right] buttons.
[ZOOM/FN] Button	Short press the [ZOOM/FN] button will enter the focal length setting state, then adjust the zoom range (auto, 20, 24, 28, 35, 50, 58, 70, 80, 105mm); long press the button will enter the advanced options setting state.
[Selection/Setting] Button	Including the [LEFT], [RIGHT], [UP], [DOWN] and [OK] buttons; through the button group can set exposure compensation, output power, intensity tuning, stroboscopic flash times, stroboscopic flash frequency, advanced options parameter and the related options of wireless flash and etc.
[Charge indicator/Test] Button	Flash output brightness can be tested by pressing this button.

### Meaning of [Charging indicator]

Statues	Meaning	Method
The red light is lit	The speedlite is fully charged and can be used.	Normal
The blue light is lit	The speedlite has not been fully charged.	Waiting for completion of charging.
The blue light blinking	Low battery and the speedlite is about to shut down.	Please replace new batteries.

### The meaning of [Sound Prompt]

The Sound Mode	Meaning	Method
Tick twice	The sound indicator is enabled,the speedlite is started or flash is ok.	Normal.
Three ticks, two times	The exposure maybe excessive.	Adjust exposure compensation or shooting condition.
Tick tick tick	The exposure may be insufficient.	Adjust exposure compensation or shooting condition.
Tick-tick Tick-tick twice	The speedlite is in the charging.	Waiting for completion of charging.
Tick-a long sound .	The speedlite is fully charged, and can be used.	Normal.
Sound in rapid succession	The power is not enough and the speedlite is going to be shut down.	Replace the batteries.
Tick-tick-tick-	The speedlite is going to be shut down.	Restart the speedlite.

## 2. Power-on and Power-off

The power of the speedlite can be turned on or turned off by long pressing Power Switch the [ON/OFF] button. It is suggested that the batteries should be taken out after power of speedlite is turned off through this button.

After turning on the power of the speedlite, the charging indicator is red, which indicates the speedlite is available.

If the charging is not completed within short time, the <Charging indicator> will with blue light blinking, and the screen will display the low power icon, speedlite will automatically shutdown, and it need to replace new batteries.

You can press the [PILOT] button to test whether the speedlite works normally.

After use, turn off the speedlite by long pressing the [ON/OFF] button.

## 3.P-TTL Mode

In P-TTL mode, the metering system of this camera will detect flash illumination reflected back from the object so as to automatically adjust flash output. And it supports exposure compensation, exposure bracketing and rear-curtain.

You can set exposure compensation for flash by pressing the [+][-] buttons, the flash exposure compensation amount can be set up to  $\pm 3\text{EV}$  in  $1/3\text{EV}$  adjustment precision. Through the [LEFT] and [RIGHT] buttons to adjust the exposure compensation by each stop, the [UP] and [DOWN] buttons for fine tuning. The exposure bracketing need to set through the camera, for the settings please refer to your camera instruction.

In P-TTL mode, short press the 【SYNC】 button will switch the sync mode between rear curtain sync/front curtain sync.

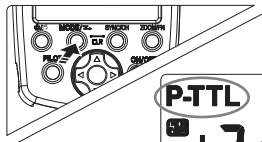

## 4.M Mode

In M mode, you can set flash brightness according to your preferences, and adjust flash brightness by the [Left], [Right], [Up] and [Down] button. Adjustment range of flash brightness is 1/128~1/1, and the brightness can be divided into 8 grades, each has maximum three grades for fine adjustment, and takes mixing grade 0.3EV, 0.5EV or 0.3/0.5EV as adjustment increment, totally 29-grade fine adjustment at most; adjust whole grade brightness with the [Left] and [Right] button, and make fine adjustment with the [Up] and [Down] button, and the adjustment result will be shown on the LED screen. When shooting, you only need to set flash brightness, adjust the camera and press the shutter; the speedlite will flash according to the sync signal of the camera.

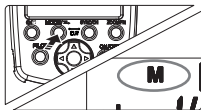

## 5.Multi Mode

In Multi mode, a rapid series of flashes is fired. The speedlite will flash according to the output power, flash times and frequency you set. Use the [LEFT] and [RIGHT] buttons to adjust output power, flash times and frequency. The adjustment scope of output power is 1/128-1/64-1/32-1/16-1/8-1/4, the scope of flash times is from 1 to 100, and the scope of flash frequency is from 1 to 100. Adjustment method: Please press the [OK] button to select setting items (flash) and use the [LEFT] and [RIGHT] buttons to adjust the flash times. After the setting is completed, press the [OK] button to confirm the setting. The flash frequency will begin to flash, use the [LEFT] and [RIGHT] buttons to adjust the flash frequency.

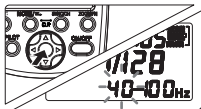
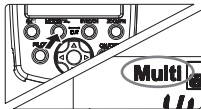

**Note:** The charging speed of speedlite is slow under the situation that the electricity quantity of the battery is insufficient, which may cause the leakage of the stroboscopic flash. Please reduce the flash frequency or change new battery under this situation.

## 6. Off-camera Flash (SP and S1/S2)

Press and hold [MODE] button to set the trigger mode. Press [LEFT] button or [RIGHT] button to select trigger mode SP/S1/S2, and press [OK] button to confirm. When SP/S1/S2 mode is working, you can rotate the flash head and let the wireless trigger sensor face toward the master speedlite. These 3 trigger modes allow to be used as off-camera slave unit and create various lighting effects.

**SP trigger mode** supports receiving wireless signal from AF-360FGZ, AF540FGZ II and built-in flash or other master units of Pentax; it also supports 4 channel, off-camera TTL and manual flash. Before shooting, the slave unit and the master unit should be to same communication channel. Setting method: press and hold [SYNC/CH] button, choose CH, and select communication channel (1/2/3/4) by pressing [LEFT] or [RIGHT] button. When use the built-in flash of the camera as the master unit, please put YN585EX (communication channel has already set) on the top of the camera, and half press the camera shutter, then, the communication channel of camera will be synchronized as the channel of YN585EX. When YN585EX works in SP mode, you can press [MODE] button to select the flash mode P-TTL/M. By operating the orientation buttons, the FEC and flash intensity can be adjusted.

**S1/S2 trigger mode** is fit for manual flash environment or TTL flash environment. In S1/S2 mode, you can adjust the output intensity by pressing the orientation buttons [UP], [DOWN], [LEFT], and [RIGHT].

**S1 mode:** When the speedlite is in S1 mode, it synchronizes with the first flash from the master speedlite,

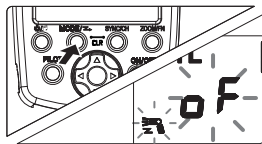

and the effect is same as when you use a wireless transceiver. To normally use S1 mode, the master speedlite should be set as manual flash, and you should avoid using TTL flash system support pre-flash and red-eye reduction function supports multiple flashes.

**S2 mode:** S2 mode is also called as “pre-flash cancel mode”. This mode is similar with S1 mode, but it can neglect the pre-flash give by TTL flash. Therefore, it supports the master flash working in TTL mode. In particular, if S1 mode cannot flash properly and synchronically with your internal flash, you can try to use S2 mode.

**Avoid the following situation when you use S1/S2 mode:** enable red-eye reduction function on the master flash; use wireless optical transmission flash mode on the master flash; use ST-E2 as flash controller. Otherwise, the flash may not synchronize.

## 7. Test Flash

No matter in which mode, you can test the flash is normal or not by pressing [PILOT] button. When testing the flash, the speedlite will give flash with corresponding output level according to the chosen output setting.

## 8. Power Saving Mode



We have designed the power saving mode for YN585EX, and the power saving mode can be achieved by setting through advanced options function. Related operation and details please refer to the subsequent “advanced options function” Chapter.

Set power saving mode from “Advanced Options Function”as below:

FN Number	Actuating Range	Settings	Power Saving Mode
01 SL EP	All modes	---	Power saving mode is off.
		on	Power saving mode is on.
03 SL Sd	SP/S1/S2	10	Slave unit idles for 10 mins and gets into sleep mode.
		60	Slave unit idles for 60 mins and gets into sleep mode.
04 SL OF	SP/S1/S2	1H	Slave unit gets into sleep mode for 1 hour and shutdown automatically.
		8H	Slave unit gets into sleep mode for 8 hours and shutdown automatically.
06 SE OF	On-top flash	---	On-top flash sleep mode is off.
		on	Idles for 3 mins/5 mins/30 mins/1 hour and gets into sleep mode; when it's in sleep mode and idles for same time length, it will shutdown matically.

## 9.Overheat Protection

When continuous shooting,the inner temperture of this speedlight rise,the overheating promptwill be displaying on the LCD screen:

Display	Level 1	Level 2
Icon		
Status of Charging indicator	Red light of bule light blinking	Red light of bule light blinking



If the speedlite is used too frequently, the overheat protection function will be triggered; the <overheat protection> icon will be displayed on LCD panel, and the speedlite will be locked. In such case, to prevent the effect on the shooting, please wait for 10 minutes before continuing use. Please try to use 1/4 output or lower when rapid shooting is needed.

**Note:** when continuous shooting, the charge indicator will be warm by a red light flashing as the flash internal temperature rises to a certain value. At this time, the flash recycling time will be extended, and it's recommended to appropriately reduce the use intensity of the flash.

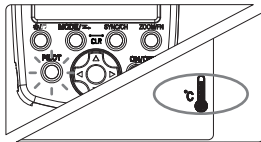

## 10. Manually Set the Zoom

**Auto zoom:** Short press the [ZOOM/FN] button to get into zoom setting, press [RIGHT] or [LEFT] button to adjust the flash coverage. If the display screen doesn't show <M>, it indicates that YN585EX can automatically adjust the flash coverage (35mm by default). Put the speedlite on the top of the camera, the speedlite moves forward/backward according to the change of the focal length of the lens to fit in the flash coverage. The auto zoom coverage is (20, 24, 35, 50, 58, 80).

**Manual set the zoom:** Short press [ZOOM/FN] button to get into zoom setting, press [RIGHT] or [LEFT] button to adjust the focal length. If the display screen shows [M], the flash coverage can be manually switched among (20, 24, 28, 35, 50, 58, 70, 80, 105mm).

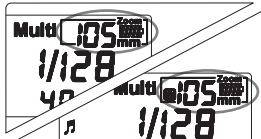
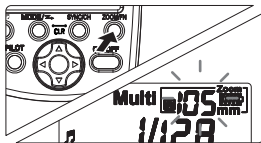

**Note:** When you use the wide panel, the flash coverage will be expanded to 14mm.

## 11.Sound Prompt

When the sound prompt is enabled, the speedlite will give out different sound for different working condition, for details please refer to the information below:

The Sound Mode	Meaning	Method
Tick twice	The sound indicator is enabled,the speedlite is started or flash is ok.	Normal.
Three ticks, two times	The exposure maybe excessive.	Adjust exposure compensation or shooting condition
Tick tick tick	The exposure may be insufficient.	Adjust exposure compensation or shooting condition
Tick-tick Tick-tick twice	The speedlite is in the charging.	Waiting for completion of charging.
Tick-a long sound .	The speedlite is fully charged, and can be used.	Normal.
Sound in rapid succession	The power is not enough and the speedlite is going to be shut down.	Replace the batteries.
Tick-tick-tick-	The speedlite is going to be shut down.	Restart the speedlite.

## 12.AF Assist Beam

When the light of the environment is in sufficient, half press the shutter to zoom automatically. The AF assist beam of the speedlite will be enabled to assist the camera focusing.

Note: When using this function the focus mode of the camera should be set as AF-S, if not, the AF assist beam is possibly not lighting.

### 13.Red-eye Reduction

The red-eye reduction function can be enabled from the camera. The speedlite will give out several flashes before the shutter opens and make the eyes of the shooting object pupil constriction. Using red-eye reduction can effectively reduce the red-eye effect caused by the flash.

### 14.PC Sync Port (Input)

Through connecting to the PC sync port, you can make the flash synchronously.

### 15. Automatic Setting Saving

The speedlite will automatically save the current settings, which is convenient to your next use.

### 16.Clear Flash Setting

The trigger mode, flash mode, flash intensity and flash coverage can be restored to the factory settings through pressing [MODE] button and [SYNC/CH] button at the same time.

**Note:** This operation won't clear the function settings from the advanced options. If clearing the advanced options settings is needed, please refer to the chapter <Advance Options Function>.

### 17.Firmware Upgrade

YN585EX is equipped with USB port. You can visit YONGNUO official website ([www.hkyongnuo.com](http://www.hkyongnuo.com)) and download the latest update software and firmware to upgrade the speedlite.

- (1) Connect the speedlite to the computer through USB-MINB connecting cable;
- (2) Keep pressing and holding [MODE] button, and then press [ON/OFF] button to start and enter the upgrade interface;
- (3) Open the update software from the computer and update the speedlite according to the reminder.

## **VII.Advanced Applications**

### **1.Wireless Radio Transmission Flash Shooting**

YN585EX can receive remote wireless signal. When it's used indoor, the maximum distance is up to 25m, and when it's used outdoor, the maximum distance is up to 15m.

In the wireless shooting process, try to keep the wireless sensor of YN585EX face toward the master unit and make sure YN585EX is situated within the effective transmitting range of the master unit.

### **2.Flash Exposure Compensation (FEC)**

To meet your needs about the shooting result, you can set the flash exposure compensation (FEC) from the camera or the speedlite. The FEC value settings range of the speedlite is from -3EV to +3EV (-3EV~+3EV). Through the [RIGHT], [LEFT], [UP] and [DOWN] button from the panel of YN585EX, you can directly adjust the FEC value. Every time you press the button, the FEC value is showed on the display screen.

### **3.Flash Exposure Bracketing (FEB)**

Flash exposure bracketing (FEB) can be set from the camera. For more specific settings please refer to the user manual of your camera. After FEB is set, the flash will automatically plus or minus compensate the exposure, such as compensating the exposure according to the sequence "Normal→Insufficient→Excessive". This function can help you to increase the success rate of the shooting.

## 4.Rear-curtain Sync

You can use slow-speed shutter to produce trailing smear for the object and the flash light will flash at the moment when the shutter is going to be shut, which means the rear-curtain sync function.

## 5.Advanced Options Function

YN585EX supports the advanced options function, which allows you custom the flash function according to your requirement. Settings method: long press [ZOOM/FN] button to enter into the advance options interface, when the display screen show the setting items, such as <SE oF 3>, it indicates the speedlite is used on the top of the camera, it's idle for 3 minutes and automatically enters into sleep mode, and, when it's in sleep mode and idle for 3 more minutes, it will automatically shut down.

Advanced options function supported by YN5685EX is as following:

### **FN NO:01**

SL EP on: Enable the power saving mode.

SP EP - - :Disable the power saving mode.

### **FN NO: 02**

AF on:Enable AF assist .

AF - - :Disable AF assist.

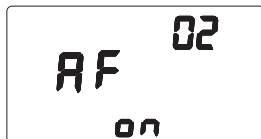
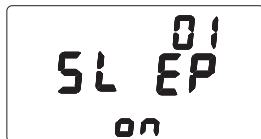

**FN NO: 03**

SL Sd 10: Slave unit idle for 10 minutes and enters into sleep mode.

SL Sd 60: Slave unit idle for 60 minutes and enters into sleep mode.

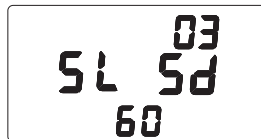

**FN NO: 04**

SL oF 1H: Slave unit idle for 1 hour and shut down automatically.

SL oF 8H: Slave unit idle for 8 hours and shut down automatically .

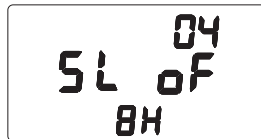

**FN NO: 05**

So nd on: Enable sound prompt.

So nd- - : Disable sound prompt.

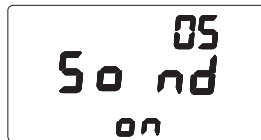

**FN NO: 06**

SE oF 3/5/30/1H: Respectively means the speedlite is idle for 3 mins/5 mins/30 mins/1 hour and enters into sleep mode; when it's in sleep mode and idle for another 3 mins/5 mins/30 mins/1 hour, the speedlite will shut down automatically.

SE oF - - : No domancy; no shutdown.

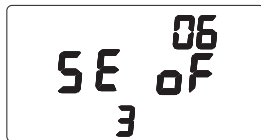
**FN NO: 07**

qu ic - - : Turn off quick power-on/power-off function (default).

qu ic on: Turn on quick power-on/power-off function.

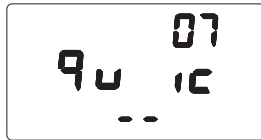
**FN NO: 08**

L cd 7/15/30: The LCD backlight duration is 7/15/30 seconds.

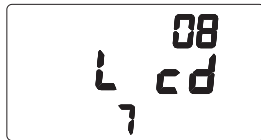

**FN NO: 09**

Inc 0.3: Manual flash output at 0.3EV for fine-tuning stride length.

Inc 0.5: Manual flash output at 0.5EV for find-tuning stride length.

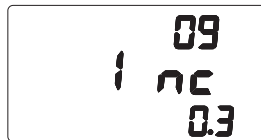

**FN NO: 10**

Firmware version of the speedlite.



**FN NO: 11**

Recover the advanced options default settings.





## 6.High-speed Continuous Shooting

This speedlite supports high-speed continuous shooting function. Please set the camera to continuous shooting mode if needed.

**Note:** The quantity of photos that can be continuously shot is related with the flash output settings, thus, please use fully charged batteries.

## 7.Reflection Flash

Bounce flash means taking photos by making flash light head aimed at wall or ceiling, and using the light reflected back from ceiling or wall to light the desired object so that the shade behind the object can be decreased to get more natural shooting effect.

If the wall or ceiling is too far, the bounce flash may be too weak to get enough exposure. The wall or ceiling should be even and white in order to get efficient reflection; if the reflection is not white, the color cast may appear in photo.

## 8. Use Reflection Board for Shooting

With the reflection board in flash, pull out the reflection board and the wide panel out from the light head at the same time, and then push the wide

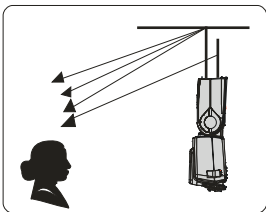
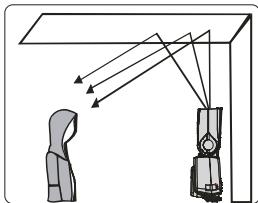

panel back. In such case, if this product is being used to take photos, it will produce a highlighted point on the eyes of the subject and thus make the eyes charming (catching light). This function can reach optimal effect when the flash head is up 90°.

### **9.Use Wide Panel**

Pull out the wide panel, push back the reflection board and arrange them as per the figure; in such case, the flash range will enlarged and the effect will be softer and more natural.

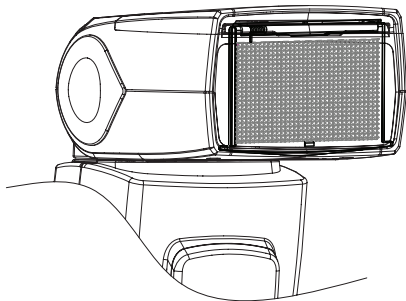

## VIII.Specifications

Circuit design	Insulated Gate Bipolar Transistor (IGBT)
Guide No	58 (ISO 100, 105mm)
Flash mode	P-TTL, M, Multi
Trigger moe	SP, S1, S2
Zoom range	Auto, 20, 24, 28, 35, 50, 58, 70, 80, 105mm
Vertical rotation angle	-7~90 degrees
Horizontal rotation angle	180 degrees towards the left/right
Power supply	4xAA size batteries (Alkaline or Ni-MH are usable)
Lighting times	100~1500 times (AA alkaline cell used)
Recycle time	Approx 3s (AA alkaline cell used )
Color temperature	5600k
Flash time	1/200s~1/20000s
Flash control	8 levels of output control (1/128~1/1), 29 levels of fine tuning
External interface	hot-shoe, PC port, USB Port
Wireless triggering distance	20m~25m indoor, 10m~15m outdoor
Additional features	rear-curtain sync, FEC, FEB, the electronic flash head zooming, sound prompt, Auto saving settings, PC sync, power saving mode, overheat protection, advance options function, AF assist beam, firmware upgrade
Dimension	60×72×188mm (extended state)
Net weight	370g
Items contained	Speedlite (1), protecting bag (1), mini stand, manual (1), manufacturer certificate (1)

Guide number of different focal length range (ISO 100, in meters/feet)

Flash output	Flash Range (mm)				
	14	20	24	28	35
1/1	15/49.2	26/85.3	28/91.9	30/98.4	39/127.9
1/2	10.6/34.8	18.4/60.4	19.8/65	21.2/69.6	27.6/90.7
1/4	7.5/24.6	13/42.7	14/45.9	15/49.2	19.5/64
1/8	5.3/17.4	9.2/30.2	9.9/32.5	10.6/34.8	13.7/45.2
1/16	3.8/12.5	6.5/21.3	7/23	7.5/24.6	9.7/32
1/32	2.7/8.9	4.6/15.1	4.9/16.1	5.3/17.4	6.9/22.7
1/64	1.9/6.2	3.3/10.8	3.5/11.5	3.8/12.5	4.9/16
1/128	1.3/4.3	2.3/7.5	2.5/8.2	2.7/8.9	3.5/11.4

Flash output	Flash Range (mm)				
	50	58	70	80	105
1/1	42/137.8	44/145.5	50/164	53/173.9	58/190.3
1/2	29.7/97.4	31.2/102.9	35.4/116.1	37.5/123	41/134.5
1/4	21/68.9	22.1/72.8	25/82	26.5/86.9	29/95.1
1/8	14.8/48.6	15.6/51.5	17.7/58.1	18.7/61.4	20.5/67.3
1/16	10.5/34.4	11.1/36.4	12.5/41	13.3/43.6	14.5/47.6
1/32	7.4/24.3	7.8/25.7	8.8/28.9	9.4/30.8	10.3/33.8
1/64	5.3/17.4	5.5/18.2	6.3/20.7	6.6/21.7	7.3/24
1/128	3.7/12.1	3.9/12.9	4.4/14.4	4.7/15.4	5.1/16.7

## IX.Possible Problems during Use and Solutions

**1.Please note when use the flash outdoors:** For outdoor application, please avoid direct sunlight to the wireless triggering sensor and ensure normal use of the flash.

**2.Precaution for outdoor use of lambency umbrella:** The lambency umbrella mounted on the flash light outdoors may be blown down easily, and the hot shoe of the flash light may be broken. Please fix the mounting rack.

**3.Photos are under-exposure or over-exposure?** Check if the set shutter, aperature and ISO are too near the flash limit or some settings including exposure compensation in relation to flash are proper.

**4.Vignetting appear in photos or only part of the subject is illuminates?** Please check current coverage of focal length and make sure the lens focal length exceeds the coverage range of the flash. This product's zooming range is 20~105mm of the APS-C system. You can try to pull out the wide-angle diffuser to expand the flash range.

**5.If the flash control panel is vague,** it's because there is a protective film on the panel. Please tear the protective film off and the visual effect will be much better.

**6.The flash light is abnormal?** Please switch off power of flash light and camera, mount the flash light on the hot shoe of camera, and switch on the power of flash light and camera again. If the abnormality continues, replace the batteries.

Updated version of this manual can be got from YONGNUO official website ([www.hkyongnuo.com](http://www.hkyongnuo.com)). The functions of this manual are based on the test conditions of our company. Further notice will not given if the design and specification change.

The YONGNUO logo in this manual includes the registered trademark or trademark of SHENZHEN YONGNUO PHOTOGRAPHY EQUIPMENT Co., Ltd in China or/and other countries (regions). All other trademark are the property of their respective owners.